

# PFEIFER DRAKO

ELEVATOR PRODUCTS

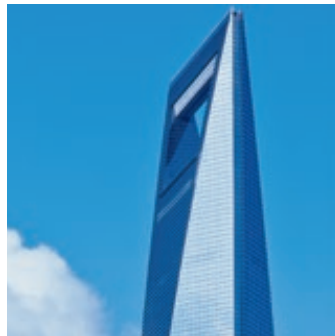
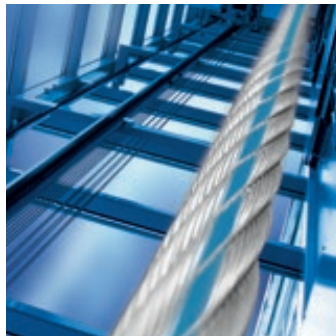

09/2019

Token fee 9,50 EUR

## Steel Wire Ropes in Elevators

**PFEIFER DRAKO  
DRAHTSEILWERK GMBH**

RHEINSTRASSE 19-23  
D-45478 MUELHEIM AN DER RUHR  
PHONE +49 (0)208-429 01-0  
FAX +49 (0)208-429 01-43  
E-MAIL [elevator\\_products@drako.de](mailto:elevator_products@drako.de)  
INTERNET [www.drako.de/en](http://www.drako.de/en)



# Steel Wire Ropes in Elevators

**PFEIFER DRAKO, an associate company of the PFEIFER Group, has produced and developed special wire ropes for the elevator construction industry for almost 200 years.** Thanks to the extensive sales & distribution network and numerous associate companies in all corners of the globe, DRAKO's special ropes are safely and reliably in use wherever people need to travel vertically. From Moscow to Kuala Lumpur, from New York to Hong Kong and also in Paris, London and Frankfurt, we build on close and long-term relations with our discerning customers. In turn, elevator manufacturers the world over have come to trust us as reliable partners.

At DRAKO, tradition and innovation share equal ranking: one aspect would not be possible without the other. Our special knowledge and the advanced development of the ropes are always state of the art. For this we have a long-standing and intensive cooperation with universities and institutes. The streamlined precision manufacture of the serial products and the management of customized projects are governed by DIN EN ISO 9001 in accordance with our own quality management system (QMS). Our company handles resources with as little impact on the environment as possible. We are certified to DIN EN ISO 50001 and 14001 as well as "Ökoprofit".

Our mission statement is defined as our adherence to the most up-to-date technical know-how, high-quality materials, safety, user-comfort and economic efficiency which are turned into a set of values transferred to our customers and enable us to embrace every challenge in a multi-cultural world.

We work to...

- the highest safety standards
- economical levels of efficiency and
- reliable service

... for the benefit of our customers, and that is our goal.



Our Production & Logistics site at Rheinstrasse, Mülheim an der Ruhr, Germany

Front cover (right): Shanghai World Financial Center, Shanghai





## Advantages of DRAKO steel wire rope

- Special wire ropes for your application
- Proven strand design and versatile adaptability
- Long service life
- DRAKO-made fiber core, constant quality
- Low elastic and permanent elongation
- Low maintenance costs
- 100 % rope quality, high quality assurance
- Fair cost-benefit ratio
- Highly qualified and experienced personnel
- Competent advice
- Reliable service
- Worldwide sales network



State-of-the-art stranding technology in the production process



PFEIFER DRAKO

## Contents

### Frequently asked questions about wire ropes in elevators

Why are wire ropes used in elevators?	4
Structure and components of steel ropes	4
Rope grade	5
Strand construction	7
Rope constructions	8
Which ropes are suitable for which elevator installations?	10
Rope core	14
Lubrication	15
Direction of lay	16
Pre-forming	17
Pre-stretching	17
Rope diameter	17
Rope terminations	19
Elevator ropes in operation	20
Storage of elevator ropes	20
Installation	21
Drive arrangement	22
Rope tension	24
Shortening of ropes	26
Spring deflection of the car under load	26
Relubrication	26
Discarding of wire ropes	28
Corrosion	30
Traction sheaves	31

<b>Guidance for the selection of ropes</b>	<b>36</b>
--	-----------

<b>Our Service</b>	<b>38</b>
--------------------	-----------

Authors of the fourth revised version of this document published 2017:

Dr. Wolfgang Scheunemann (TCC) – Michael Döffinger  
(Product Management) · PFEIFER DRAKO · Mülheim a.d. Ruhr

Authors of the third revised version of this document published 2015:

Dr. Wolfgang Scheunemann (TCC) – B.Sc. Martin Stroba  
(Product Management) · PFEIFER DRAKO · Mülheim a.d. Ruhr

Authors of the second revised version of this document published 2011:

Prof. Dr. Wolfram Vogel (TCC) – Thomas Schonlau (Product Management) –  
Dr. Wolfgang Scheunemann (TCC) · PFEIFER DRAKO /  
Mülheim an der Ruhr, Germany

Authors of the first revised version of this document published 2007:

Dipl.-Ing. Thomas Barthel – Dr. Wolfgang Scheunemann –  
Dr. Wolfram Vogel (all TCC at PFEIFER DRAKO)

Author of the original document:

Dr.-Ing. Michael Molkow / Mülheim an der Ruhr, Germany

# Frequently asked questions about wire ropes in elevators

## Wire ropes

### Why are wire ropes used in elevators?

Due to its design and a structure made up of many individual steel wires, steel wire rope offers advantages which clearly qualify it for use on elevators. Its benefits are

- its redundancy and
- the capacity to identify the possibility of the end of service life or preferably the correct time for discarding the rope before its condition becomes dangerous by means of externally visible criteria such as.



Fig. 1: Fibre core, strand, wire

## Stress factors

### In what way are wire ropes exposed to stress when travelling over the traction sheave?

When running over the traction sheave and the deflection sheaves, the wires in the ropes are exposed to a high complex of stress factors comprising tension, flexural stress, torsion and compression – which all lead to material fatigue. During flexural stress, the wires bend in relation to each other. The friction created between the wires results in additional abrasive wear. In addition, the influence of corrosive media may be added. With increasing use, the abrasion characteristics become more pronounced, for example, the number of wire breaks over defined reference lengths increases. Regular inspection permits the correct time for changing the rope to be determined or the remaining service life to be estimated.

### What is meant by redundancy?

Redundancy actually means superfluity, a factor which is of extreme importance in the case of safety-relevant applications. A basic distinction is drawn here between active and passive redundancy. Active redundancy is provided by the interaction between wires laid jointly to create a rope or the multiple arrangements of suspension ropes in elevator systems. If one component fails, the remaining components take on its functions in line with their configuration. Passive redundancy relates for example to safety gears which only move into action in the event of an uncontrolled travel movement.

## Structure and components of steel ropes

### Why do the wires in the strands and the strands in the rope have a helical structure?

## Structure of steel ropes

The helical structure (Fig. 1) addresses the fact that an elevator rope is bent over a sheave. This effect becomes evident if we imagine first a parallel wire bundle being bent over a sheave (Fig. 2). The inner wires lying on the sheave are too long and the outer wires too short.

Premature failure is the anticipated result. In a wire rope (Fig. 3), the areas with excess length and those with insufficient length lie one next to the other when running over a sheave, i.e. the strand only needs to shift marginally to achieve length compensation. For the individual wires in the strands, the same principle applies. When running over the sheave, all components – strand against strand and wire against wire – are in continuous movement.

Fig. 2: Parallel wire bundle running over a sheave

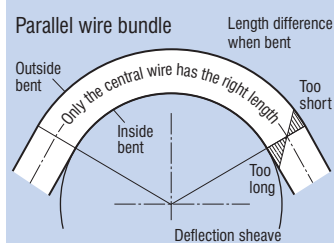
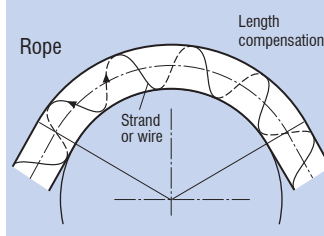

Fig. 3: Rope running over a sheave



## The material

### What makes steel wire so special?

The raw material for steel wire is unalloyed carbon steel with carbon content of 0.4 or better 0.6 to 0.8% by weight. Other materials such as silicon and manganese are only present in minimal quantities as regulated by DIN EN ISO 1612 [1].

Steel wires for elevators have nominal tensile strengths of 1370, 1570 and 1770 N/mm<sup>2</sup>. Higher strength levels of up to 2500 N/mm<sup>2</sup> are possible with special approval. A steel wire achieves these extremely high strength levels by a process of manufacture which combines forming with heat treatment. This entails passing rolled wire with a diameter of between 5 and 10 mm

through “nozzles” (wire drawing dies) by repeated drawing when cold to gradually reduce the diameter. During this process, its tensile strength increases by a factor of 3 to 6. Before the first and between the drawing processes, the material is exposed to controlled heat treatment, which performs a process known as patenting. The relatively high tensile strength of the steel wires – characterized by extreme microstructure banding – is consequently not the result of factors such as a high content of alloying elements, but of material forming which has occurred when in a cold condition (Fig. 4 and 5).

**Influence of temperature**

Heat damages the wire. It is said that the high-strength banded forced microstructure regains its original strength of around 400 N/mm<sup>2</sup>. The period of exposure to heat by fire, friction heat, radiated heat, light arcs and heat from welding etc. also exerts an effect on the residual serviceability properties of the wire. At a temperature of 480 °C, a complete microstructure transformation takes place after 15 to 30 minutes. At higher temperatures, just seconds can be enough to cause permanent damage to thin wires of the kind used in products such as elevator ropes.

**Special material**

Consideration is being given in various places to the possible use of alternative wire materials made of stainless steel. However, ropes made of these materials have little to recommend them for use in traction elevators due to their inferior fatigue bending properties compared to ropes made of carbon steel wires. Moreover, they demand an extremely high price.

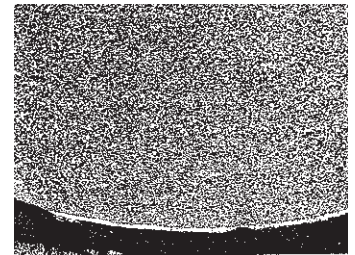

Fig. 4: Material microstructure, cross section

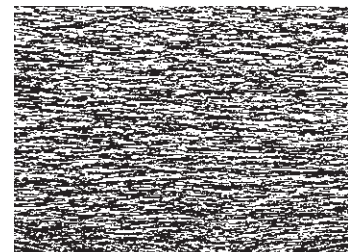

Fig. 5: Material microstructure, longitudinal section

**What is the significance of wire nominal tensile strength?**

The nominal tensile strength of wires can be set within broad limits. What strength is finally used depends on a range of factors, often also determined by traditional values. These include low sheave hardness levels and also locally applicable regulations and customs, Fig. 6. If the sheave has a low hardness level, it must be borne in mind that the hardness of the wire depends upon its tensile strength. Experience has shown that by using soft sheave materials together with “non-hard” wires, rope imprints can be avoided in the grooves. But in seeking an explanation, it is not sufficient to state that, for instance, wires with a nominal strength of 1370 N/mm<sup>2</sup> are simply not as hard as those with a strength of 1570 N/mm<sup>2</sup>. In this case, the wire strength drops only from 470HV (445HB) to 410HV (390HB). Even the “softest” wire in a rope of strength class 1370/1770, i. e. having outside wires with a nominal tensile strength of 1370 N/mm<sup>2</sup>, is still twice as “hard” as a “well designed” sheave with a hardness of between 210 and 230 HB.

One reason why low rope grades are customary in certain localities can be regionally applicable regulations permitting low rope safety factors (higher rope pull forces). This is only apparently contradictory. Due to high levels of contact pressure, a higher degree of groove wear or the effect of rope imprints occurs.

**Rope grade**

European and international elevator rope standards EN 12385-5 [2] also 4344 [3] have coined the term “rope grade” to describe rope strength. It defines the nominal tensile strengths of the outer and inner wires, and assigns the rope a defined minimum breaking strength. Rope grade 1370/1770 means that a rope has a “mixed strength” (termed “dual tensile” in ISO 4344) in which the outer wires of the outer strands have a nominal tensile strength of 1370 N/mm<sup>2</sup> and the inner wires of the rope have a strength of 1770 N/mm<sup>2</sup>. Rope grades used for suspension ropes and governor ropes are summarized in Fig. 6. Based on a suitable wire material (carbon steel content and purity level matching the targeted wire nominal tensile strength), wires in the rated strength range of 1350 to 1800 N/mm<sup>2</sup> demonstrate practically the same fatigue bending properties under the same degree of stress.

For elevators in high-rise buildings with their “weighty” mass of ropes, higher rope grades of 1770 are frequently used because of their higher breaking strengths. 1770 rope grades are also preferred for the operation of drum-driven elevators and roped hydraulic elevators.

# FAQs

Fig.6: International rope grades commonly found

Country	National name of rope grade	Type	Equivalent rope grade		
			Traction elevator	Roped hydraulic elevator	Governor rope
Europe	1370/1770	Dual tensile	1370/1770	1370/1770	1370/1770
Also in France, Germany, Italy, England	1570	*	1570	1570	1570
	1770	Dual tensile *	1570/1770 1770	1570/1770 1770	1570/1770 1770
	1960	*	–	–	1960
England	1180/1770	Dual tensile	1180/1770	–	–
USA	Traction Steel	Dual tensile	ca. 1180/1770	–	ca. 1180/1770
	extra high strength Traction Steel	Dual tensile	ca. 1570/1770	–	
	Iron	Dual tensile	–	–	ca. 700/1180
Japan	Grade E to JIS (3525)	Dual tensile	1320/1620**		
	Grade A	*	1620	1620	

\* Rope consist of wire with only a single nominal wire tensile strength  
 \*\* Due to changes in the standard, nominal wire strength 1320 also possible

In some cases, suspension ropes with wires of rope grade 1960 are manufactured. However, these are no longer regulated in accordance with EN 81-20/2014 and require special approval (certificates of conformity or compliance). For governor ropes, these restrictions do not apply, and here 1960 grade ropes are used in combination with hardened sheaves.

## What is the correlation between the strength and hardness of wire?

### Strength/hardness of wire

Wire hardness rises on a linear basis with nominal wire strength (Fig. 7), which is lower in elevator ropes compared to for example crane ropes. The limited nominal wire strength and consequently limited wire hardness should protect the traction sheave against wear. However, Fig. 7 also shows that the wire is always far harder than the unhardened sheave (Brinell hardness HB). Measurement of the wire micro-hardness (Vickers hardness HV), which is occasionally requested by elevator producers in the Far East, only makes sense if soft sheave material and low rope safety factor necessitate the use of a “non-hard” wire material. Generally speaking, the correlation between wire tensile strength and wire hardness follows the progression shown in Fig. 7 for all carbon steel wires with a certain scatter range. More detailed information is provided in DIN ISO 18265 [4].

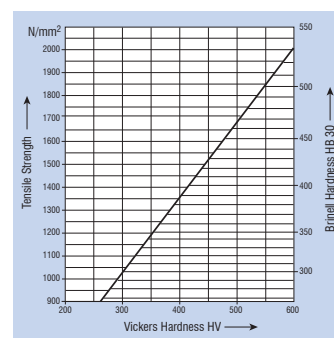

Fig. 7: Tensile strength, Brinell / Vickers hardness

### Protection against corrosion

## How are wires protected against corrosion?

The elevator rope is customarily made from bright wires. The light lubricant coating on the wires in elevator ropes is generally sufficient as a protection against corrosion in dry lift shafts. Nevertheless, this protection against corrosion is usually only adequate for purposes of transport warehousing and the first period of operation. We recommend that this kind of protection be regularly inspected and renewed. For outdoor elevators, elevators operating in extremely damp or humid climates or in aggressive environments, the steel ropes should be made of galvanized wires. This type of rope has proven successful in lifts over decades. Water-resistant lubricants should be used in their manufacture and for relubrication. In the tropics, where torrential downpours of rain pose the ever-present risk of water penetration in the lift shaft, the governor rope should be galvanized even for indoor elevators. Due to the higher costs involved, the lower fatigue bending strength and so on, stainless steel ropes are little suited for use as elevator ropes.



**Strand construction**

**Parallel strand construction**

**Strands**

Suspension ropes for traction elevators are regularly produced using Seale, Warrington and Filler strand constructions. Figures 9–11 illustrate the strand constructions for a Seale (1-9-9), a Warrington (1-6-6+6) and a Filler (1-6-6F-12) rope, each with 19 strands. Less commonly used, and then generally for larger rope diameters, are Warrington-Seale strands (Fig. 12).

The above listed strands in the parallel strand construction are characterized by the fact that the lay length of the wires in the strand is identical, with one wire from the outer ring positioned in linear formation in the channel provided between two wires below. No wires cross over each other in the strands, so markedly reducing the incidence of abrasion (Fig. 8).

In standard strand constructions known today as cross lay constructions, wires cross over each other in the strand. In these strands, the wires make contact with each other at specific pressure points, resulting in high levels of pressure between the wires and secondary flexural stress. Due to the increased wear and the risk of internal wire breaks, the standard construction is little suited for elevator ropes, but is still found in some cases in the form of thin ropes, for example in dumb waiters and speed limiters.

When designing a strand, it is important to take into consideration the fact that most wires in the strand cross-section appear in the form of ellipses. Consequently, the process of designing and monitoring the structure of high-performance elevator ropes is performed nowadays using special calculation software programs.

**What is a Seale strand?**

The world’s most frequently used strand construction for elevator ropes is the 19-wire Seale strand (1-9-9). Because of the thick outer wires, the Seale strand offers a higher degree of resistance against external wear in use when running over the traction sheave and the deflection points.

**What is a Warrington strand?**

The Warrington strand features far thinner wires in the outer wire circle than a Seale strand. This makes for a marked reduction in flexural stress. During fatigue bending tests on round grooves, ropes made of Warrington strands with a 1-6-6+6 construction achieve around 20 to 40% longer service life than comparable ropes made using Seale strands. Ropes made from Warrington strands are popularly used in traction elevators with double wrap drives and in roped hydraulic elevators. One reason why both Seale and Warrington are encountered as strand constructions for elevator ropes in countries such as Germany and the UK.

**What is a filler strand?**

Ropes made using the filler strand construction also offer very good fatigue bending properties. Based on fatigue bending tests, the 8 x 21 filler strand with fibre core (strand: 1-5-5F-10) has been adopted by Canadian elevator standards. Elevator ropes with a diameter of over 16 mm (5/8”) should be designed with a filler construction (1-6-6F-12) due to their improved flexibility (Figure 11). The filler strand is sensitive to geometrical distortion. This applies in particular to inaccurately selected wire diameters of filler wires. In the case of ropes with rope diameters lower than 10 mm, a filler construction is not advisable due to the extreme thinness of the filler wires.

**What is a Warrington-Seale strand?**

Warrington-Seale strands are used where large rope diameters are involved in which the outer wires of a Seale strand would become excessively thick, but a high abrasive resistance is imperative. This applies in the case of compensating ropes with a diameter of around 24 mm and for suspension ropes with a diameter around 22 mm. It is advisable to change over to

Fig. 8: Position of strand wires in parallel constructions

next wires are parallel to one another

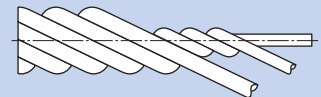

all layers have the same lay length

Fig. 9: Seale

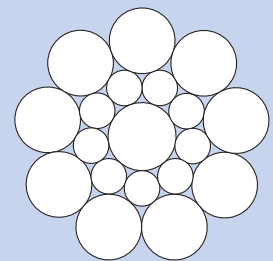

Fig. 10: Warrington

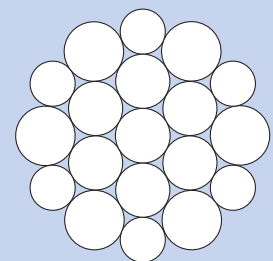

Fig. 11: Filler

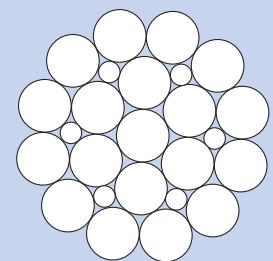
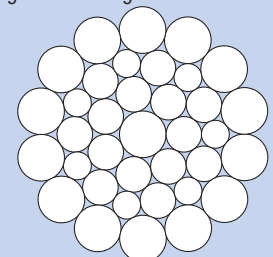

Fig. 12: Warrington-Seale



this strand construction when using rope diameters in this range. In some cases, well lubricated ropes with a 6x26 Warrington-Seale construction (strand structure 1-5-5+5-10) have proven the ideal solution for elevator drive systems with a large number of sheaves positioned closely with one behind the other and reverse bending. Ropes produced using a Warrington-Seale construction is sensitive to disturbances to the rope geometry and/or running on traction sheaves with V-grooves or U-groove with undercut. They should preferably be used with round grooves.

## Ropes and rope constructions

### Rope constructions

The simplest elevator rope is obtained by laying 6 strands, for example using the Warrington construction, around a fibre core (Fig. 19). Up until the 1950s, this was practically the only kind of rope used. Since this time; the demands imposed on traction drive elevators in terms of speed, shaft height and traffic flow as well as expectations of ride quality have increased tremendously.

The changing ratio of elevator car weight to payload has given rise in some cases to calculations which are unfavourable, for example in terms of traction capability. Today, the 8-strand rope with natural fibre core has made great inroads in the international arena, and can be considered as the most frequently used elevator rope today (Fig. 20 and Fig. 21). For medium long to very long shaft heights and for no-compromise demands on ride comfort and on the necessity of high rope breaking strengths, the 8-strand and 9-strand steel core rope designs have already gained an important position on the market.

## Which rules, regulations and requirements apply to ropes in traction drive elevators?

### Rules, regulations

In order to prolong the service life of a rope, the contact pressure between the rope and groove must be restricted. This results in a minimum number of ropes and minimum rope diameters. The calculated contact pressure is dependent upon the rope surface and independent of the breaking strengths, and consequently also the rope cross-section area. TRA 003 [5] / EN 81-1/1986 [6] take into account a simplified form of pressure calculation. For historical reasons, the conceptual basis for setting the permitted limits of contact was in fact a 6-strand rope, which is why the number of six contact points was also assumed and a corresponding value set. Yet with the use of 8 and multiple-strand ropes, due to the rise in the number of contact points, it was also found possible to proceed on the basis of a higher limit value. This is no longer evident in EN 81-1/1998 [7] and is now addressed by a special calculation of the rope safety factor as per Annex N. However, the factor of contact pressure should always be borne in mind. High minimum safety factors (ratio of minimum breaking strength to operating load) of 12 (USA and Japan 10) require only a minimal metallic cross-section in the rope. But precisely because of the adverse effects of pressure reducing the service life, the rope diameter as a factor must be taken into account. This is why the 8-strand rope with fibre core, which adequately complies with the calculated requirements (relatively low breaking strength coupled with relatively high rope diameter) is in such widespread use. Further considerations to improve the performance of ropes are:

- small permanent elongation (fewer rope shortening processes),
- small elastic elongation (car suspension, ride comfort),
- small diameter reduction in operation (discard age),
- longer rope service life due the use of thinner wires in greater quantities,
- the rope should be more rounded than an 8-strand rope, the actual contact pressure is reduced by the existence of more contact points between the rope and the side of the groove and
- the rope should remain round in operation and should in particular adjust to hardened U-grooves with a larger undercut.



Fig 13: Overview of full steel elevator rope constructions

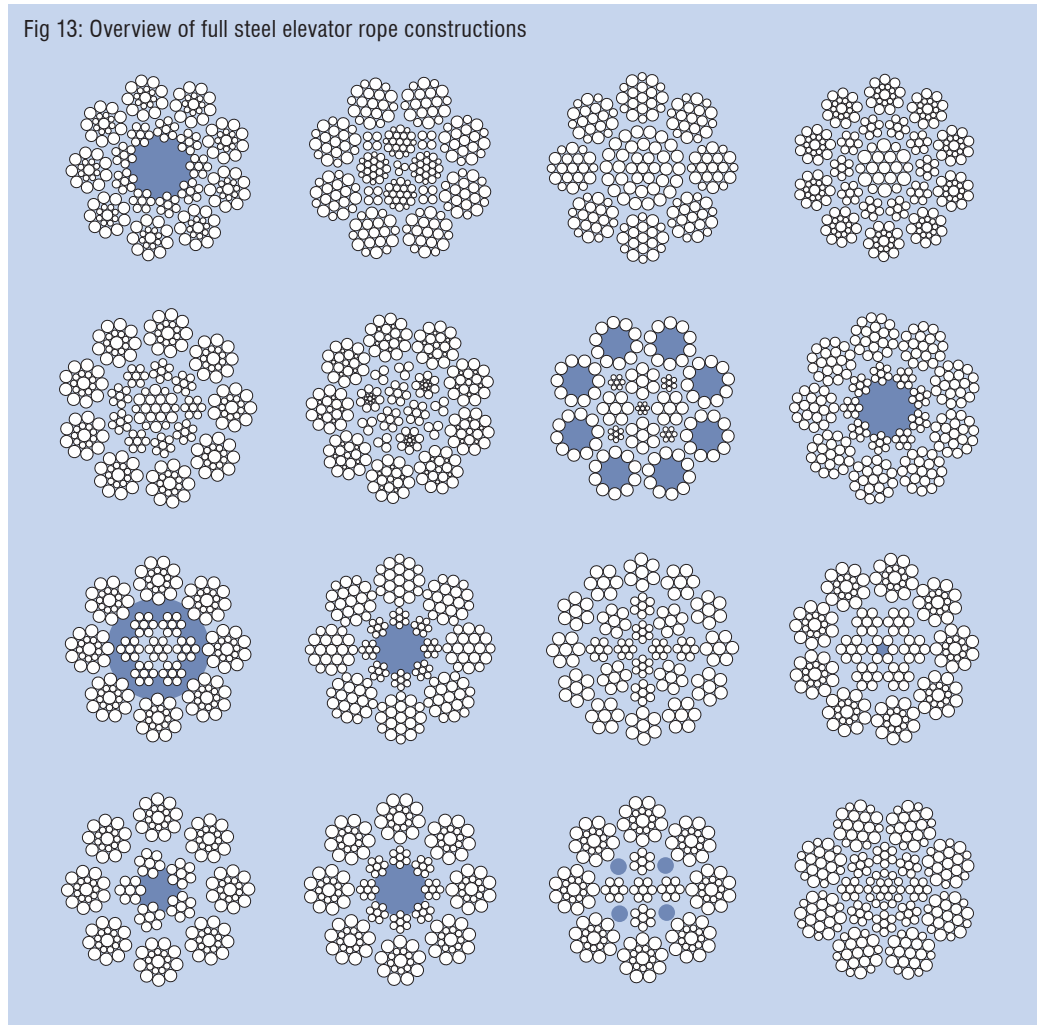

This long list of requirements can be met by using full steel ropes, with the number of outer strands being additionally increased to nine. Fig. 13 illustrates examples of full steel ropes. Fig. 23 illustrates a proven 9-strand elevator rope construction with steel wire core. Following the highly successful use such elevator ropes with steel wire core in a number of complex and demanding building projects, they have now been included in the current international standards.

It is worth pointing out that, for many years, Germany was the sole pioneer in the manufacture and application of elevator ropes with steel wire core. But even today some elevator manufacturers abroad wrongly assume that this type of rope is prohibited in their country, because the only elevator standard applicable in that country is one for ropes with fibre core.

When using ropes with a steel wire core, it should be made clear that the enhanced benefits of longer service life and reduced rope elongation can be considered as an alternative to an installation being designed with a standard 8 x 19 + fibre core construction and it can be operated using the same number of ropes of the same thickness with steel wire core. However, if the increased minimum breaking strength of these ropes is used as a reason to reduce the number of ropes or the rope diameter, then the aforementioned advantage would be "exhausted", at least partly.

Rotation-resistant rope constructions (Fig. 14) should not be used in traction drive elevators, as these entail crossover of the outer and inner strand layers and high contact pressure levels. This leads to the danger of unnoticed inner rope damage.

Fig. 14: Rotation-resistant rope constructions (example)

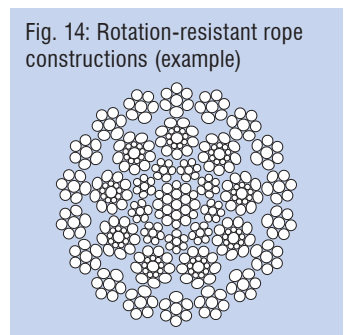

# FAQs

## Diversity in construction

### Why this degree of diversity in elevator rope constructions?

Does the single ideal elevator rope exist, or to take this possibility even further, could there actually be one rope to cover all conceivable applications? A rope used in traction drive elevators is exposed to a complex collective of stress factors comprising flexure, tension and compression but also abrasion between the wires and between the rope and sheave due to the unavoidable effect of slip. A high level of flexural stress calls for the use of a large number of thin wires in the outer strand layers. Under extreme wear conditions, thick outer wires would be preferable. In other words the rope and strand construction must be selected depending on the predominant source of stress. If exposed to high levels of flexural stress, preference would be given to a Warrington rather than a Seale rope. Added criteria when it comes to selecting the right rope, however, include special country and manufacturer-specific factors and traditions.

Rope selection is additionally influenced by the restrictions in terms of diameter for certain types of rope construction. Due to the extremely thin filler wires, 8 x 25 filler construction ropes (a rope with an extremely good fatigue bending life) are not produced in diameters less than 10 mm. A 6 x 19 Seale construction cannot be used in diameters over 16 mm because the thick outer wires would result in excessive rope rigidity.

This goes some way towards explaining the wide diversity of rope constructions in existence. Added to this is the wide variation in traction drive elevators themselves. This diversity means that a single rope construction would never be sufficient to achieve optimum behaviour. The bandwidth of different elevators produced ranges from traction drive elevators with many varied shaft heights, roped hydraulic elevators and dumb waiters, taking in widely differing car suspensions and counterweights etc. Other contributory factors to the variety of constructions are tensioned balance ropes on high speed installations and the ropes used in overspeed governor devices. In brief: it is impossible to address all the different application requirements, cost and benefit expectations with just a single rope construction. The use of high-performance ropes for a rarely used, slow-moving elevator can be eliminated if only for reasons of cost. Conversely, simple rope constructions are out of place in high-rise installations. In addition, all the rope constructions illustrated in Fig. 13 are special ropes which are not available from all manufacturers across the entire bandwidth. It is also essential to bear in mind in this debate that differential force brought about as a result of the different masses of the elevator car and counterweight has to be transmitted through friction between the rope and sheave. This calls for verification of what is known as the traction capability, which falls back on the model of the ideal round rope illustrated in Fig. 15. This procedure has a proven successful track record in this area. However, the traction capability only constitutes one side of the coin. The actual installation conditions of the rope in the groove naturally play a major influencing role in determining the service life of the rope. This is impressively demonstrated by the example of a full steel rope with 6, 8 and 9 outer strands in undercut U-grooves with an extreme undercut angle of  $\beta = 105^\circ$  (Fig. 16 to Fig. 18). The right-hand illustration shows the rope with a rotated cross-section relative to the left-hand illustration, but with a fixed rope centre point. In most cases, a large number of strands and a dimensionally stable full steel rope is a suitable construction in most cases (Fig. 18).

Fig. 15: Rope and traction sheave, schematic view

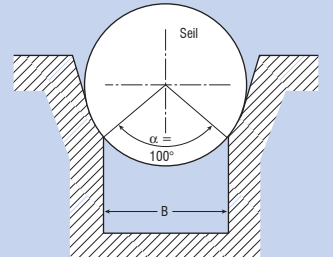

Fig. 16: 6-strand rope in 105° U-groove

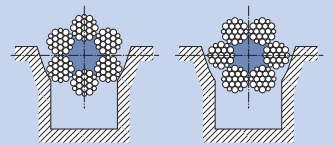

Fig. 17: 8-strand rope in 105° U-groove

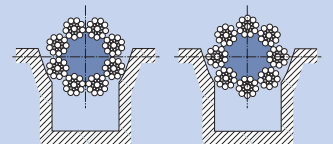
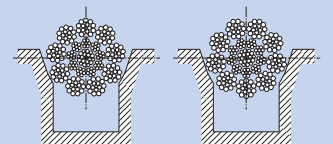

Fig. 18: 9-strand rope in 105° U-groove



## Selection of rope

### Which ropes are suitable for which elevator installations?

The appendix to this document provides a simple aid for the selection of suspension ropes, tensioned balance ropes and governor ropes depending on the installation. It also explains which aspects resulted in the assignment of type of rope/elevator installation.

### What is required of suspension ropes for traction drive elevators?

The requirements imposed on ropes used in traction drive elevators are sometimes contradictory, even to the point of conflict. In summary, these requirements are:

- the smallest possible degree of rope wear (thick wires, high wire tensile strength),
- a long rope life when running over sheaves (thin wires),
- compatibility with the sheave (low wire tensile strength),
- the highest possible breaking strength (fewer or thinner ropes, high wire tensile strength),
- low rope elongation due to rope shortening processes and ride comfort expectations (high metallic cross-section and top-quality fibre core) and
- a low price (steel and suitable core material cost money).

These requirements can clearly not be fulfilled comprehensively. Compromises are often called for, though it may be noted at this point that, with increasing shaft height, it is the rope elongation factor which mainly determines the choice of rope.

### 6-strand

#### When is a 6-strand rope with fibre core used?

Fig. 19 illustrates an example of this type of rope in the form of a 6 x 19 Warrington with fibre core. The benefits and fields of application are outlined in the following.

Benefits:

- a larger metallic cross-section, i. e. high breaking load relative to the rope diameter,
- relatively low permanent and elastic elongation
- favourable price per metre.

Field of application:

Slow travelling freight elevators and low-duty passenger elevators.

The use of this type of rope should be reconsidered for U-grooves with large undercuts or V-grooves.

Fig. 19: 6x19W + NFC

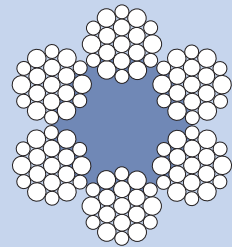

Fig. 20: 8x19S + NFC

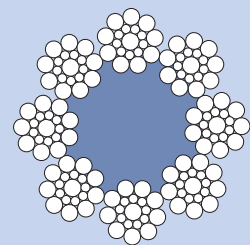

Fig. 21: 8x19W + NFC

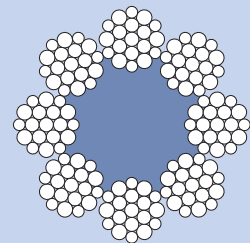
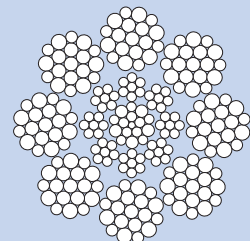

Fig. 22: DRAKO 250 T,  
8x19W + IWRC



### 8-strand natural fibre core wire rope (NFC)

#### When is an 8-strand rope with fibre core used?

Fig. 20 shows an example of this type of rope in the form of an 8 x 19 Seale with fibre core. The benefits and fields of application are outlined in the following.

Benefits:

- 8-strand ropes are rounder than their 6-strand counterparts, so creating more points of contact between rope and groove, and consequently ensuring more favourable contact pressure conditions,
- a slightly more deformable cross-section, i. e. the rope adjusts more easily to slightly worn grooves,
- 8-strand ropes have thinner wires than 6-strand ropes of the same construction and diameter, i. e. the rope is less rigid and offers better fatigue bending characteristics, and
- a medium price per metre.

Field of application:

The 8 x 19 Seale construction with natural fibre core (Fig. 20) is internationally the most frequently used elevator rope. However, the 8 x 19 Warrington rope construction with natural fibre core (Fig. 21) also has a wide following due to its superior fatigue bending characteristics. It should be noted that the rope quality depends heavily upon the quality of the fibres used to produce the fibre core.

#### When is an 8-strand rope with steel wire core used?

The 8-strand rope with steel wire core (Fig. 22) offers most of the benefits and very few of the drawbacks of 8-strand ropes with fibre core.

Benefits:

- 8-strand ropes are rounder than 6-strand ropes,
- 8-strand ropes with steel core keep their round cross-section in operation and are thus ideally suited for grooves with a large undercut,

### 8-strand independent wire rope core (IWRC)



## FAQs

- 8-strand ropes of this type are more flexible and offer good fatigue bending characteristics,
- little or no permanent or elastic elongation,
- low rope diameter reduction under load, also over time and
- high breaking load relative to diameter.

Field of application:

The 8-strand rope offers an easy-maintenance solution for high-duty elevators, and is used preferably for rope lengths of between 50 and 100 m.

### 9-strand IWRC

#### When is a 9-strand rope with steel wire core used?

The 9-strand elevator rope was developed in 1955 as one of the first elevator ropes with steel wire core, in the shape of the DRAKO 300 T (Fig. 23).

Benefits:

- a very round cross-section, and therefore low contact pressure between the rope and groove,
- a large number of thinner wires, and therefore very good fatigue bending characteristics. In addition, a special arrangement of the wires in the strands and the strands in the rope helps to prevent wire crossing, and so reduces the danger of internal wire breaks invisible from the outside.
- minimal permanent and elastic elongation and therefore good precision stopping even in shafts with long travel heights.

Field of application:

The 9-strand elevator rope is the best solution as a suspension rope for all elevator installations with large shaft heights and also for traction drive elevators with a large number of deflection sheaves.

Fig. 23: DRAKO 300 T, 9x25F + IWRC

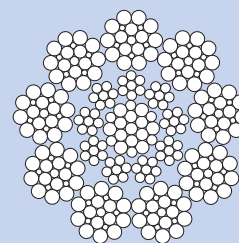

#### What are parallel laid ropes?

### PWRC (parallel wire rope core)

In the rope constructions illustrated so far, the rope core and the outer strands are laid independently of each other in separate work processes. These ropes are durable and relatively insensitive to loosening as a result of external effects, for example due to rope deflection. The rope construction of the DRAKO 300 T, which has stood the test of time over decades, also comes in the double parallel design. In a parallel laid rope, the rope core and strands are laid in a single work process with the same length of lay, whereby the outer strands are placed in linear formation in a bed formed by two strands of the rope core, Fig. 24. These ropes demonstrate a high breaking strength and in some cases very high fatigue bending characteristics. The large metallic cross-section leads to higher breaking strengths and to lower elastic and permanent elongation. These ropes also possess a very round rope cross-section. But they are susceptible to untwisting during the installation stage and/or under diagonal pull. Preferred fields of application are systems where great demands are placed on precision stopping during loading and unloading procedures with simple rope run.

It is important to ensure that the rope termination – and this applies to all elevator ropes – is secured against rotation. When used for longer shaft heights, the ropes should untwist as little as possible during installation i.e. a maximum of 5 twists over 100 metres shaft height. The grooves of the drive sheave should be inspected when changing ropes. Expedient here is a marking line on the rope that will help to check the alignment of the rope and, if necessary, to re-adjust it.

Fig. 24: DRAKO 300 TP

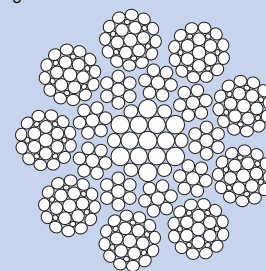

#### Which suspension ropes are used for roped hydraulic elevators?

### Roped hydraulic elevators

In the case of roped hydraulic elevators, the suspension ropes only run over deflection sheaves with round grooves. The absence of a drive sheave means that in this instance liberally lubricated ropes can be used. Furthermore, the use of round grooves makes for higher specific rope tensile forces. The typically used rope constructions here are 6-strand ropes with

fibre core (Fig. 19), and 8 and 9-strand ropes with steel wire core (Fig. 22 and Fig. 23). The customary rope grade is 1770, and for ropes with a steel wire core occasionally even 1570 and 1570/1770.

### Compensating rope

#### What are compensating ropes (tensioned balance ropes)?

For traction elevators, tensioned balance ropes are stipulated as a method of weight compensation and to limit compensating weight jump brought about by the safety gear or the buffer. The suspension and balance ropes differ fundamentally in terms of their application conditions. The experience of past decades has culminated in special balance rope constructions permitting greater rope service life, quieter running and consistent rope lengths. These constructions are based on the following requirements:

- an extremely round cross-section and consequently minimal contact pressure between the rope and groove,
- a large number of thin wires and consequently extremely good fatigue bending characteristics,
- use of thicker and thus fewer ropes and smaller in width tensioning sheaves,
- use of thicker ropes with small  $D/d = 30$  and consequently the ability to select flexible multiple-wire rope constructions, Fig. 25.

Rope rotation cannot be excluded, as frequently 2 tensioning sheaves are arranged side by side. This can be triggered initially by alignment errors. Premature rope damage is possible. Ropes with a natural fibre core respond under typically low balance rope forces to changing humidity in the shaft (construction phase, monsoon climatic conditions etc.) by marked changes in length. Synthetic fibre cores have been shown to provide a solution to the problem. 6-strand ropes with a high weight and synthetic fibre core are recommended as balance ropes. For rope diameters of  $d = 13$  to 25 mm, for instance, 6x25 Filler and for larger nominal rope diameters, 6x36 Warrington Seale constructions are used. Steel ropes such as DRAKO 300 T also find use here.

Fig 25: 6x36WS + NFC

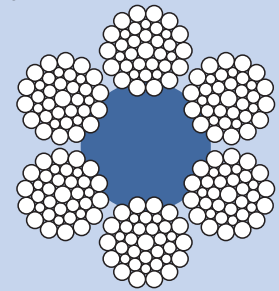

### Governor rope

#### What are overspeed governor ropes?

Governor ropes are an essential functional element of the overspeed controller, which engages the safety gear when an overspeed situation is detected. The governor rope runs in the moulded groove of the governor pulley for smaller and medium speeds. When the safety gear is triggered, force is transmitted by friction between the rope and groove. Consequently, the amount of rope lubrication plays a significant role. In recent years, increasingly stringent demands have been made on breaking strengths, which are increased as a result of larger rope diameters, higher rope grades or the use of full steel constructions (e. g. DRAKO 6x19W WSC or 250 T).

Usually, traditional 6-strand rope constructions with fibre core are used as governor ropes, in most cases 6 x 19 Warrington + FC as illustrated in Fig. 15. These are generally speaking ropes with a diameter of 6 mm or 6.5mm in rope grades 1770 and in some cases even 1960. However, EN 81-20 excludes rope grade 1960 for use in suspension ropes, but allows it for governor ropes. With increasing shaft heights and rope lengths, the degree of rope strength required also increases. This results in the use of governor ropes with rope diameters of between  $d = 8$  and 10 mm, and in some cases up to 13 mm with an 8 x 19 Warrington or 8 x 19 Seale + IWRC rope construction, Fig. 18.

As a rule, at speeds of over 2.5 m/s, a certain proportion of modern overspeed controllers do not decelerate the governor rope by blocking the governor pulley, but by means of closing brake shoes. The governor rope required for this design must not have excessively fine wires or strands. Although most of the above described rope constructions have proven successful on many different overspeed governor designs, responsibility for determining the correct type of rope construction to be used should lie with the overspeed governor manufacturer.

## FAQs

---

If ropes with fibre core are used as governor ropes in particularly tall buildings, preference should be given to ropes with synthetic fibre cores. However, in this case these should be subjected to rigorous pre-stretching in order to limit their elongation in operation. This is particularly important given that governor ropes must be pre-tensioned and the tensioning path is limited. In the USA, a certain proportion of governor ropes of strength class IRON are still encountered. The nominal tensile strength stipulated for the outer wires in these ropes of 700 N/mm<sup>2</sup> is due to the brass brake shoes used in some speed governors. If steel ropes complying with higher rope grades were used, these would presumably run the risk of excessively fast wear.

### Rope core

#### Rope core

Depending on the intended application, two different core types are used in elevator ropes: fibre cores made of natural or synthetic fibres, and steel wire cores, as well as a mix of steel core with fibre component.

### What is a fibre core?

#### Fibre core

In elevator ropes, fibre cores made of natural or synthetic fibres are used. Natural fibres – generally Sisal – are the most widespread for application in ropes. Due to their ductility, ropes with fibre cores are able to adjust up to the relevant groove shape, if within limits. The benefits of DRAKO fibre cores are

- resistance to contact pressure,
- the long-term support effect for the strands and
- low deformability.

The drawbacks are that

- good yarn qualities (i. e. thin, even yarns) are expensive and not easy to come by,
- the material absorbs moisture from the ambient air and
- rotting is a possibility.

The fibre can be seen as a lubricant store. Its ability to absorb high quantities of grease can also become a drawback, however. Storing too much lubricant during manufacture and giving off too much during operation result in fast rope diameter shrinkage, as grease pressed out of the fibre core equates to a loss of volume in the fibre core.

Synthetic fibres such as polypropylene (PP), which is in popular use for crane ropes and cable car ropes, are also used for elevator ropes. Ropes with this type of core are frequently involved where groove wear takes place on the sheave with a hardness of below 200 HB. Despite the many benefits, it must be borne in mind that fibre cores for elevator ropes with small diameters of 7 mm and below made of natural fibres cannot always be manufactured to an adequate degree of diameter accuracy, no matter how meticulously produced.

Fibre cores made of polypropylene offer the benefit of immunity to rotting in humid environments and also to volume change caused by moisture absorption. The drawbacks of the PP core are its high elastic elongation and associated increased risk of rope imprints being created in sheaves.

For governor ropes and balance ropes in installations involving long rope lengths, in particular in environments with high levels of humidity, chemical fibre cores would be the preferred choice. Natural fibres absorb moisture, making the core thicker and the rope shorter. Where longer governor rope lengths are used, the height at which the tensioning pulley has to be fitted is not sufficient to compensate for excessive rope stretch. Polyamide fibres have produced excellent results as fibre cores for ropes running in round grooves due to their resistance to pressure. However, they come at a relatively high price. Fig. 26 provides a comparison of the various fibre materials available for fibre cores in elevator ropes. The tasks performed by lubricants will be illustrated at a later juncture. Yet it may be stated that



Fig. 26: Rope core material comparisons

Fibre material	Grease absorption without problems, approx.	Benefits	Drawbacks
Natural fibre / sisal	up to 17%	good grease absorption, pressure resistant, low longitudinal elastic elongation	sensitive to high air moisture
Natural fibre / hemp	up to 22%	good grease absorption, good strand foundation, low longitudinal elastic elongation	lower diameter accuracy than sisal, sensitive to high air moisture
Natural fibre / jute	up to 20%		only for ropes smaller than 6 mm
Synthetic fibre polypropylene	up to 12%	uniform thickness	not very pressure resistant, ductile, melts at high temperatures
Synthetic fibre polyamide	up to 8%	highly pressure resistant, uniformly	low grease absorption, expensive, high longitudinal elastic elongation, fusibel
Synthetic fibre aramid, e. g. Kevlar / Dupont	not known low anyway	fibre nearly as strong as steel, heat resistant up to 350 °C	as pure fibre difficult to handle, as fibre core, very expensive

special controls are imposed on the evenness of the core and also on the amount of lubrication. The influence of the rope core on the service life of ropes is frequently underestimated.

### Steel wire core

#### What is a steel wire core?

Steel wire cores increase the metallic cross-section and so reduce tensile stress in the individual wires. Ropes with steel wire core are subject to lower elongation under the same load conditions as ropes with a fibre core. The steel wire core can take on widely differing forms (Fig. 13). The steel wire core can be manufactured separately (independently) in a preceding work step prior to being formed with the outer strands (Fig. 22 and Fig. 23). Another variant is to produce the steel wire core and the strands in a single work step, i. e. in parallel (Fig. 24). The outer strands and the strands of the steel wire core are placed – in a similar way to the wires in parallel laid ropes – so that they make linear contact with each other.

One factor that all ropes with steel cores have in common is that the ropes must not be permitted to rotate during installation. Although it is true to say that ropes should always be laid with care, the negative influence of rope rotation in ropes with fibre cores is less pronounced than is the case in ropes with steel wire cores. While in ropes with fibre cores all the strands become evenly longer or shorter when the rope rotates, in ropes with steel wire cores the outside and inside strands loosen to a different degree. This can result in pronounced differences in terms of load carrying capacity and consequently serve to shorten service life. Rope damage, possibly caused by protruding core strands, cannot be ruled out.

#### How important is the lubrication of strands and cores during manufacture?

### Lubrication

Wires, strands and cores are important components of the rope, which however are only able to interact ideally in the presence of lubrication between the wires. The only reason a rope is able to bend so easily is because the wires are capable of displacement relative to each other. Sufficient lubrication reduces friction between the wires. However, in particular in the case of elevators, it is totally false to assume that “the more the better”. On the contrary, an elevator rope which is subjected to frequent bending over sheaves over a service life of many years must be lubricated well but to a precisely controlled degree. It should be noted in this context that the lubricant does not impair the necessary traction, which is determined by the geometry of the traction sheave but also by the coordinate of fric-

## FAQs

tion between rope and sheave. Thought should also be given to the risk of contamination by lubricant spun off under centrifugal force. Traction elevators differ considerably depending on their design in terms of the traction reserve, in other words the difference between the theoretically available traction and the traction used. Elevator ropes are seldom produced specifically for one elevator installation. Rope manufacturers should always base their calculations on the worst case scenario and only lubricate elevator ropes with a relatively minimal quantity, with extreme care and as evenly as possible. Due to the long service life of ropes in elevator installations, particular attention is attached to relubrication. Here, the same requirements apply as for initial lubrication, whereby steps must be taken to ensure that lubricants used for initial and subsequent lubrication are chemically compatible. For application in traction elevators, lubricants containing bitumen are not ideal, as they tend to form highly viscous adhesive encrustations on both sheaves and ropes. Friction-reducing elements such as molybdenum sulphide or Teflon particles should be dispensed with, as their influence on traction can be very difficult to predict and they unnecessarily add to the cost of the application. The relubricant to be used must be approved by the rope manufacturer. For more information revolving round the topic of rope lubrication, please see EN 12385-3.

### Direction of lay

#### What is the significance of the direction of lay?

A distinction is made when considering the direction of lay between right and left-hand lay ropes. As a rule, elevator ropes are right-hand lay ropes, i. e. the outer strands form a right-hand helix. As a result of the torque created by the attempt of the elevator rope to reverse the laying status under torsional load, elevator installations used to be equipped with right and left-hand lay ropes in pairs. This allowed compensation of the forces acting on the guide rails of the car and counterweight resulting from the twist due to load. But since these forces are only small relative to those forces generally absorbed by the guide rails, in modern elevator installations priority is given to the requirement that all suspension ropes be as nearly identical as possible, i. e. should always originate from the same source of manufacture. The mixed use of left and right-hand lay ropes, which can only be produced using separate manufacturing processes, has generally been abandoned. Even so, the use of right and left-hand lay ropes in pairs may still be necessary in older systems based on a non-guided counterweight, for example. In drum-driven elevators, the drum pitch must be selected to match the direction of rope lay, i. e. "right-lay rope – left-hand drum".

### Lay

#### What do regular lay and Lang lay mean?

In the same way as the strands in the rope, the wires in the strands can be laid in left or right-lay wires. Regular lay is used to describe a different lay direction for the outer strands in the rope and the wires in the outer strands. If the wires in the strand and the strands in the rope have the same lay direction, this is described as Lang lay. In regular lay ropes, the visible outer wires follow approximately the direction of the rope axis. In Lang lay ropes, the visible outer wires are inclined at a steep angle to the rope axis.

### Regular lay

#### What characterizes a regular lay rope?

Regular lay ropes are hard-wearing and easy to mount. They have only a slight tendency to untwist when hanging freely in the shaft. The elastic elongation is lower than is the case in Lang lay ropes. Plus, detecting the end of service life (discard age) by visible outer wire breaks is made easier. These benefits mean that the majority of elevator manufacturers use regular lay ropes exclusively.



Fig. 27

### Lang lay

#### What characterizes a Lang lay rope?

In round grooves, Lang lay ropes achieve greater bending resistance than regular lay ropes. However, they are more sensitive to diagonal pull and place more stringent demands in terms of installation. Steps must be taken when hanging the ropes freely in the shaft to prevent untwisting, as otherwise the wires will work loose and result in premature rope damage. A "sharp" undercut angle can damage the crossing outer stands of a Lang lay more easily as well. Also, detecting end of service life end by means of externally visible wire breaks can, under certain circumstance, be much more difficult on account of the larger wire tensions inside the rope. The degree to which Lang lay ropes are accepted differs widely around the world. While they are given equal status in countries such as the UK, in Germany their use is subject to certain provisos.



Fig. 28

### Pre-forming

#### Why pre-formed ropes?

In pre-formed ropes, the inner tensions of the wires used in the strands and the strands used in the rope are reduced, with the result that when the rope binder is removed, pre-formed ropes do not spring open. This substantially simplifies the processes of cutting to length and installing. Pre-formed ropes are also known as low-tension or low-twist ropes. Pre-formed elevator ropes have become the standard design in Europe today.

### Pre-stretching

#### Why are ropes pre-stretched?

Elevator ropes are pre-stretched in order to induce compaction of the rope structure, which otherwise only takes place with the first load cycles after hanging, prior to start-up. This means that the permanent rope elongation (= permanent rope stretch) which accompanies compaction of the rope structure is reduced, so minimizing the amount of work involved in shortening the ropes after only a short period of use.

#### How are ropes pre-stretched?

Experienced elevator rope manufacturers use suitable measures to achieve a pre-stretching effect during production by applying load to the rope by pull-off during the stranding process. More intensive pre-stretching calls for a separate work process. ISO 4344 restricts the maximum tensile force applied during pre-stretching to approx. half of the minimum breaking strength. Several stretching procedures may be required.

#### When does it make sense to pre-stretch a rope?

The most notable effect is achieved when pre-stretching 8-strand ropes with natural fibre cores. Here, 0.2% permanent rope elongation can be achieved, as the strands become permanently more deeply embedded in the fibre core. In the case of ropes with steel wire core, the effect of pre-stretching on permanent elongation is relatively low. In addition, the pre-stretching effect is partially lost due to the handling of pre-stretched full steel ropes during the installation process.

## Rope diameter

### Rope diameter

#### Which rope diameters are used in the elevator sector?

The adjacent diagram indicates the most commonly used rope diameters in Europe, the USA and Japan (East Asia). For certain European countries, the most commonly used suspension rope diameters are additionally marked in each case. Beyond this, 24 mm ropes are also used in the high-rise sector. Although rope diameters smaller than 8 mm are not covered by the current version of EN 81-20, elevator installation using 6.5 and 6 mm (DRAKO 250 T) ropes already exist, operated on the basis of a separate type approval certificate from a notified body. The development of rope diameters of such small proportions is being driven by the trend towards machine-room-less elevators with small, fast running drive machines.



# FAQs

Fig. 29: Rope diameters most commonly used

Rope diameter		Europe			USA		Japan
mm	inch	Traction susp. rope	Roped hydraulic susp. rope	Governor rope	Suspension rope	Governor rope	Suspension rope
6		x <sup>1)</sup>		x			
6.5		x <sup>1)</sup>		x <sup>2)</sup>			
8		x <sup>2)</sup>	x	x			x
9		x					x
	3/8				(x)	x	
10		x <sup>3)</sup>	x	x			x <sup>7)</sup>
11	7/16	x <sup>4)</sup>	x		x		
12		x					x <sup>6)</sup>
	1/2				x <sup>5)</sup>	x	x
13		x <sup>2)</sup>	x	(x)			
14		x					x
15		x					
15.5		x					
16	5/8	x			x		x
	11/16				x		
18		x		x			x
	3/4				x		
20		x					x
	13/16				x		
22	7/8				x		x

<sup>1)</sup> FC only for small freight elevators <sup>2)</sup> most common rope in Germany <sup>3)</sup> most common rope in France <sup>4)</sup> most common rope in UK <sup>5)</sup> most common rope in USA <sup>6)</sup> most common in Japan <sup>7)</sup> officially minimum diameter in Japan

## Certificate concerning the examination of conformity CA067

Limitation to  $D/d \geq 40$  is effected by PFEIFER DRAKO by the certificate concerning the examination of conformity CA067 for the ropes DRAKO 250 T  $d = 6, 6.5$  and  $8$  mm in that the safety factor  $S_f$  and diameter ratio  $D/d$  can be selected practically on an arbitrary basis through adhering to CA067  $S_f \geq 12$  and  $D/d \geq 18.5$  ( $d = 6.5$  mm). Evidence for traction capability must be presented beforehand in order to have set a groove form already. Decision-assistance graphs show the expected number of rides for specific elevator configuration and permit a reflection of expected traffic for the elevator system.

## How is the diameter of elevator ropes measured?

The rope diameter must be measured within one layer and offset by  $90^\circ$ . If there is an even number of outer strands, measurement must take place over two opposite strands, for an uneven number of strands over one strand and the opposite gap between strands (Fig. 30). The mean value must be formed from the two diameters.

## Which rope diameter tolerances between ropes are admissible?

For elevator ropes, in particular suspension ropes for traction elevators, the tolerance requirements are more stringent than for other wire ropes, in order to guarantee low-wear transmission of forces between the sheave and rope. DIN EN 12385-5 specifies the limiting measures depending on rope core and rope nominal diameter. PFEIFER DRAKO recognizes the tolerances set out in DIN EN 12385-5 for full steel rope but, in doing so, implements them more strictly than the standard. Tolerances are set in the non-tensioned state and for parts of minimum rope breaking strength (Fig. 31).

Fig. 30: Diameter measurement / steel wire ropes

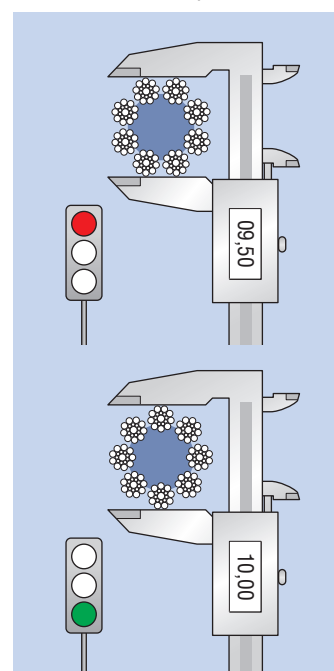

## Tolerances

Fig. 31:  
Diameter tolerances  
acc. with EN 12385-5

Rope nominal diameter d [mm]	Tolerances for the rope diameter as-is					
	Rope with steel core			Rope with fibre core		
	Unloaded	5 % F <sub>min</sub>	10 % F <sub>min</sub>	Unloaded	5 % F <sub>min</sub>	10 % F <sub>min</sub>
d ≤ 10 mm	0 % to 3 %	≥ d	≥ 0.99d	0 % to 6 %	≥ 1.01d	≥ d
d > 10 mm	0 % to 2 %			0 % to 5 %		

### Rope terminations

## Rope terminations

A distinction is made between detachable and permanent rope terminations, of which only those illustrated in Fig. 32 are regularly used in elevator construction. The terminations comply with the conditions laid down by EN 81-1:1998 Section 9.2.3 or EN 81-20/2014 Section 5.5.2.3.

A termination with wire rope grips in accordance with EN 13411-5 is not listed and is not recommended for safety-relevant applications. The requirement for securing against untwisting (rotation) after installation applies to all end terminations.

### What is metal and resin socketing?

In Germany, metal and resin socketing is practically no longer relevant as a method of end termination for elevator ropes, while in the USA [8] and in the Far East, this type of rope is still in use. The socketing deviates significantly from EN 13411-4 [9] and can only be classed as safe in any respect in combination with small rope forces in the elevator. The benefit of socketing is its relatively lean construction. Alternatively, plastic socketing can be used. Nevertheless, it should be pointed out that future elevator standards in Europe will prohibit socketing.

### Metal and resin socketing

### What is an aluminium ferrule?

An aluminium ferrule termination as specified in EN 13411-3 [10] is commonly used in Europe. It is mainly used in elevator construction in conjunction with a thimble [11] and eye bolt (Fig. 32). This type of termination is frequently used in combination with a wedge socket at the other end of the rope. Pre-assembled ex-factory, the aluminium ferrule cannot be attached during rope installation. The ferrule is an extremely secure termination which – apart from a few exceptions such as the USA – meets with very broad acceptance. This makes it all the more regrettable that in the USA and other countries, the aluminium ferrule is met with a certain degree of distrust.

### Aluminium ferrule with thimble

### What is a swaged termination?

A swaged termination is a very slim construction which permits a wide range of different connection possibilities. Swaged terminations connect the steel sleeves and ropes permanently together using the swaging methods of pressing or rolling. The elegant style of the finished connection makes this type of termination a favoured option in prestigious open-design applications such as hotels. They are also popular where space is at a premium, for instance car arrangements with rucksack hanger. Swaged terminations generally have to be secured against rotation. The insert depth of the rope in the swaged terminations and consequently the swaging length is decisive for functional safety. By looking through the inspection hole provided at the end of the insert path, a check can be made to ensure the end of the rope is fully inserted into the sleeve.

### Swaged fitting with thread

Fig. 32: Rope terminations in elevator construction

#### Aluminium ferrule with thimble



#### Swaged terminal



#### Symmetric wedge socket EN 13411-7

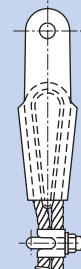

#### Asymmetric wedge socket

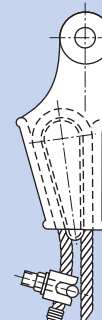

## FAQs

---

### Symmetric wedge socket

#### What is a symmetric wedge socket?

The symmetrical wedge socket described by EN 13411-7 [12] is common in Germany, UK, Italy and also Japan, Fig. 32. To secure the dead end of the ropes, only a grip in compliance with EN 13411-5 [13] may be used.

### Asymmetric wedge socket

#### What is an asymmetric wedge socket?

The asymmetric wedge socket in compliance with EN 13411-6 [14] (Fig. 32) offers advantages in terms of rope guidance, but has the drawback of a relatively bulky design. This can generally be compensated through the use of long eye bolts in staggered formation. Caution is called for in situations where slack rope is created. Unlike the symmetrical wedge socket, with this socket type it is possible for the wedge to drop out. The dead rope end has to be secured with a rope grip in compliance with EN 13411-5. It is not admissible for both ends of the rope (end under load and dead end) to be terminated together with this type of socket.

### Wire rope grip

#### What is a wire rope grip?

The European Lift Standard DIN EN 81-20 will in future no longer permit the termination of ropes with wire rope grips. The use of wire rope grips should be rejected in applications of such high safety relevance as lifts anyway. and be restricted to securing rope dead ends in the case of wedge sockets.

Temporarily shortening a rope using a wire rope grip is an extremely hazardous exercise which should be avoided without fail. Since the parts of the rope at which a wire grip has previously been located subsequently run over sheaves, there is a high likelihood of the rope fracturing prematurely at these points. Even if rope grips are fixed onto the rope as an aid to installation, this should only ever be done in areas of the rope which do not later run over rope sheaves.

### Securing against rotation

#### Securing against rotation

Rope terminations as installed must be secured against rotation to prevent rope structure changes coming about, changes which may adversely affect service life.

## Elevator ropes in operation

### Storage

#### How should ropes be stored?

Elevator ropes are usually made up of bright wires which are not protected against corrosion. They are given a relatively minimal coat of lubricant. Consequently, over extended periods of storage prior to installation, ropes should be protected against corrosion. Ideally, they should be stored in a dry, frost-free and dust-free environment. Contact with cement dust or sand should be avoided in particular. When covering ropes for their protection, care must be taken to ensure adequate ventilation in order to prevent the formation of condensation, for instance where temperature conditions fluctuate, please see DIN EN 12385-3.

### Unrolling

#### How should ropes be unrolled for mounting?

The ground rules for rope mounting must be observed at all costs. By removing from the side via the reel coupling or from the coil strap, the rope is opened or closed depending on the direction of lay. This twisting action brings about a change in the rope structure which can no longer be corrected. In the case of ropes with steel core, this type of forced rotation creates uneven strand lengths. The result is an uneven distribution of load in the rope bundle and the emergence of strands which have been extended beyond their normal length.

Fig. 33

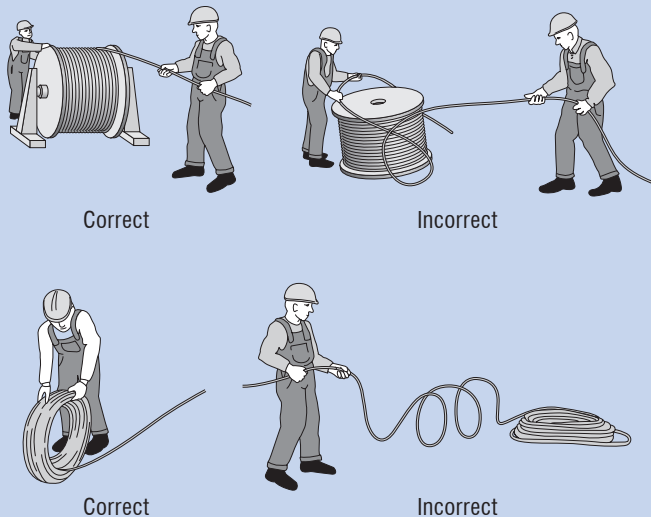

Fig. 34:  
“Kink”



Fig. 35:  
“Braid”



**What is the reason for kink formation and how can it be remedied?**

**Kink**

Carelessness, for example during unrolling, will in most cases cause torsion in the rope (twist). If this in effect turns the rope into a braid (Fig. 33), then it can only be remedied by turning the end of the rope. Violent rotation at the braid itself or pulling on the rope will nearly always culminate in the formation of a kink. The resulting damage makes the rope unusable, and it must be replaced (Fig. 34).

**Why do ropes untwist?**

**Untwisted wire ropes**

Where long lengths are involved, a rope can untwist just under its own weight when hanging freely in the shaft without having been secured against rotation. The same effect occurs if the rope is pulled upwards using a thin auxiliary rope. Lang lay ropes, ropes with steel wire core and in particular double parallel ropes are especially susceptible in this context. They react extremely sensitively if commissioned when in this condition. The loosened rope is incapable of absorbing loads evenly distributed over all the rope elements as intended by the design, and can be destroyed as early as the very first load cycles. For this reason, DRAKO ropes are supplied with a marking line which makes incorrect rotation easily recognizable. It is mandatory to pay attention during the installation process to avoid twisting.

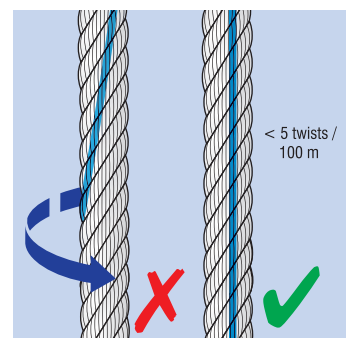

**What are the “lurking dangers” inherent in rope installation?**

**Installation**

Sharp concrete or steel edges represent a major hazard for ropes. If they are drawn over this type of edge under load – and in some cases the weight of the rope can be sufficient – they will sustain permanent damage. This type of damage is evident in the rope when in an unloaded condition by a corkscrew-like deformation, which when under load is almost impossible to detect. To avoid this hazard, rollers or at least rounded wooden beams should be used for rope deflection.

Sandy or dusty soils are highly damaging for ropes. The lubricant on the surface of the rope sticks to the loose dirt particles and forms a rough layer, which damages both the rope and the sheaves during operation. This effect can also compromise smooth running, as large dirt particles in particular can cause the ropes to run unevenly off deflection and traction sheaves, which can result in rope vibrations.

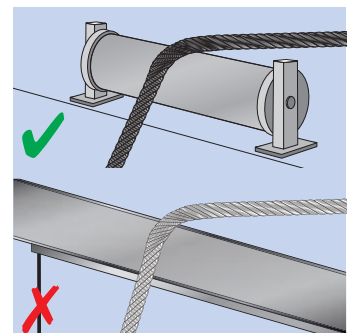



Fig. 36: The laterally positioned machine

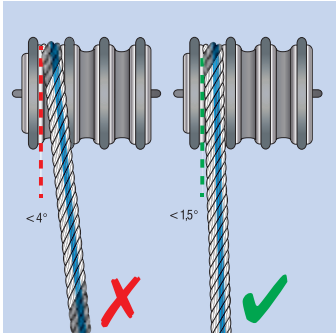
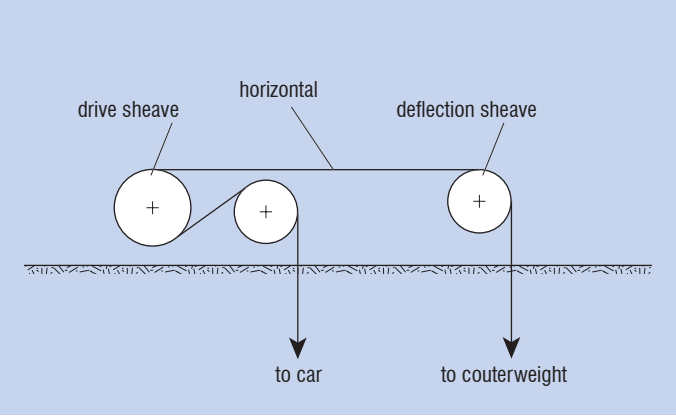

Fig. 37: Lateral deflection when running over a sheave

Some forms of damage caused by improper installation methods only become evident after a relatively short period of operation. The ropes demonstrate horizontal wear lines in parallel formation in certain areas, while other parts of the rope are almost intact. One cause for this phenomenon is the use of an unsuitable fixture for tensioning the ropes, for example in order to measure the weight of the car or the counterweight. The resulting rope deformation, and in certain circumstances additional kinking, result in local damage in the form of wire break nests, making the rope open to immediate replacement.

**Drive arrangement**

**How does the drive arrangement affect the rope?**

Consider this example: For various reasons, the elevator drive system is arranged as shown in Fig. 36 either at the top or at the bottom of the shaft (not shown) each laterally positioned with a counter-bend and a long horizontal stretch of rope. The reduced space requirement comes at a price: The ropes are bent in opposite directions, which severely compromises rope service life.

Another problem inherent in this arrangement is brought about by the horizontally running ropes, which have a tendency to vibrate. The vibration energy is concentrated at the point at which the ropes run onto the sheaves, so increasing the internal mechanical tensions in the rope. This additional stress results in premature fatigue of the wires, culminating in wire breakage. The vibrations occurring in the horizontal area of the rope following deflection produce vertical vibration of the car and the counterweight, creating an obvious detrimental effect on ride comfort. Plus, droning or buzzing noises will be triggered in the car and in the shaft.

In the case of elevators with a 2:1 suspension, the individual deflection sheaves are rotated by up to  $90^\circ$ . Depending on the construction and the resulting deflection points, the ropes may have a tendency to vibrate and impact on each other. This type of impact does not of necessity result in a reduction of service life, but it does create a perceptible noise to passengers in the elevator car. Another problem encountered by ropes is depicted in Fig. 37, namely that the ropes do not make central contact with the deflection sheaves, but are slightly offset. Depending on the properties of the grooves (opening angle, surface roughness), this circumstance causes the ropes to rotate. The possible reaction of the rope to this phenomenon is influenced by its structure (Lang lay, regular lay). In unfavourable circumstances, a Lang lay rope can become untwisted, whereby the strands also offer no resistance to the rotation. In the worst case scenario, a regular lay rope can be untwisted to the point where the wires in the outer strands block this rotation process. Although comparatively speaking this is the less critical of the two situations, it should also be avoided.

When using ropes with a steel core, assessment of the external torque must be carried out in a similar way. An IWRC rope will always work against torque effect, either by means of the inner or the outer section. In the case

of parallel laid full steel rope (PWRC), the rope bundle can in unfavourable circumstances be permanently destroyed, resulting in strands emerging from the inner section of the rope. This risk highlights once again the urgent necessity for securing ropes against rotation in an elevator installation at the end termination points.

### Lateral arrangement

#### Lateral arrangement of the traction drive

Positioning the machine laterally at the bottom of the shaft results in more pronounced rope deflection than is the case with the machine positioned above. Due to the extreme rope length, more frequent shortening may be anticipated. The high number of sheaves required exerts a highly negative impact on service life.

Positioning the machine laterally at the top of the shaft reduces the necessary rope length compared to a bottom positioned machine. With this drive arrangement, the benefit is countered by the fact that all the sheaves must be taken into account when calculating the anticipated service life.

In installations entailing particularly “labyrinthine” rope guidance with a correspondingly high number of sheaves, deficiencies can arise in terms of traction. Although this does not bring about uncontrolled car movement, it does cause occasional slip of the traction sheave under the rope.

### Rope tension

#### How does rope tension affect elevator ropes?

When designing and calculating elevators, the assumption is made that all the ropes proportionally transfer the same tensile force. In practice, this hardly ever happens. Deviating relative rope tensile forces are practically unavoidable.

In installations involving great shaft heights, the frequently deployed method of pulling or pushing on the rope is not adequate. Special rope tension measuring devices provide assistance here, offering a method of adjusting the rope tensile force to an approximately even level. Fig. 38 shows the DRAKO Weight Watcher MSM12, a multiple rope measuring device, in operation. Indeed, practical experience confirms that a tolerance field of 10% will lead to good carrying capability results for an acceptable time input. Meanwhile, uneven tension levels bring about different degrees of contact pressure on the grooves of the traction sheave, resulting in corresponding differences in rope slippage. In some cases, this brings about uneven wear in the grooves and ropes. Consequently, all ropes should be tested after an initial operation phase for even load. Experience has shown that this inspection should be carried out after 4 to 6 weeks. In some cases, delaying this inspection has resulted in premature wear of ropes and/or sheaves.

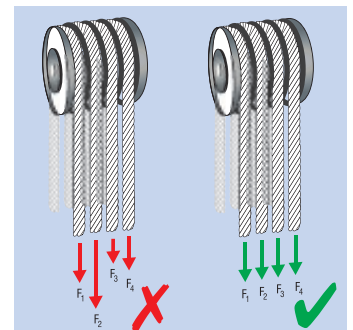

#### Why does rope vibration occur on the elevator?

Rope vibrations bring about noise development in the elevator and also a possible reduction of service life.

Transversal rope vibration can be approximately calculated using the following formula [15] for a vibrating wire:

$$f = \frac{n}{2 \cdot l} \cdot \sqrt{\frac{F}{q}}$$

f = vibration frequency [Hz = 1/s],  
 n = 1 ... basic vibration,  
 n = 2, 3 ... for the harmonic component,  
 l = length [m],  
 F = rope force [N = kg · m/s<sup>2</sup>] and  
 q = specific rope weight [kg/m].

This type of transversal rope vibration – as described in the context of drive-position-related issues – is caused by factors such as horizontal rope alignment or deflected rope paths. Conversely, vibrations in the direction



Fig. 38: Simultaneous measurement of rope tensile force

## FAQs

---

of the rope axis are caused by the stick/slip-effect on the traction sheave, caused by flank pitch errors of the gear, errors in the electrical controller or at acceleration / deceleration. The interaction between the rope and groove geometry when the rope runs off the traction sheave can also bring about vibrations.

### Reduction of vibration

#### Can vibration be eliminated or reduced?

Initially, the elevator installation should be inspected to ascertain the condition of rope lubrication and equal tensions on the ropes, and these factors corrected if required. Another check refers to measurement of the running diameter of the rope in the traction and deflection sheaves. Slight eccentricity (ovalization) can result in an intrinsic vibration from the ropes when combined with any unfavourable deviation in the grooves. The loss of ride comfort will be clearly noticed.

A vibrating system can be “retuned” using certain measures, such as selecting a higher weight per metre or changing the rope rigidity. This has often proved a successful remedy for this problem.

### Rope elongation

#### What is meant by rope elongation?

Rope elongation is one of the most frequently misunderstood terms and the cause of much confusion. This is due to there being no unequivocal elasticity module that exists for ropes that can predict the elongation of the rope over its complete service life. Since the concept of “elasticity module” is normally only used in connection with the elongation behaviour of work materials and also due to the redundant arrangement of the carrying wires, we will here use the term of “**rope elongation module**” for the steel wire rope component.

The issue is further complicated by factors such as

- rope shortening in connection with initial elongation,
- levelling in respect of loading and unloading the car to ensure floor level
- bouncing of car (or counterweight) and
- acceleration / deceleration.

### Rope elongation module

#### Rope elongation module

The mechanical characteristics of suspension ropes used in traction sheave lifts are required to comply with ever more stringent mechanical requirements, due partly to the height of modern buildings and ensuing increases in the required vertical rise. An important aspect here is rope elongation under load, and consequently the deflection of the elevator car to floor level during operation and during loading and unloading. In order to describe these deflections, the rope elongation module must be known relative to safety factors typical for the elevator in question. This is particularly significant, given that the rope stress elongation curve is non-linear in shape and the rope elongation module is not constant.

The definition of the rope elongation module has been set out in detail in publications such as Feyrer and Jahne [16] and Feyrer [17] independently of the technical application in question and/or the machine. In the field of elevator technology, there is a notable absence of any definitive standardized definition for the rope elongation module. The rope elongation module is determined using a variety of non-standardized approaches, and generally under the conditions stipulated in DIN EN 1993 [18] or VDI 2358 [19], which bear no correlation to the conditions prevailing in the field of elevator technology. ISO 4344 [3] provides no indications relating to the rope elongation module. This gives rise to a distorted reflection of reality and expectations of rope users. Pfeifer DRAGO has developed a new (internal) measuring specification (ETM 04/2017) for the application of ropes in elevators.

The following describes the rope elongation module and deals with it against the background of the safety factors appertaining to elevator construction. Methods used to determine the rope elongation modules under specific elevator conditions are discussed, and current elevator rope designs presented.

The rope elongation module describes the elongation behaviour of steel wire ropes in the longitudinal direction under the influence of mechanical stress. The rope elongation module is determined from the rope stress elongation curve based on static tension testing. These rope stress elongation curves are distinctly non-linear. The rope elongation module is therefore not a constant and is dependent on a range of rope and stress parameters. These parameters exerting a significant influence on the rope elongation module include the rope construction, rope core, tension level during loading and unloading cycles and the utilization status of the ropes. A distinction is made in tangent and secant elongation modules, whereby a difference is drawn according to the tangential rope elongation modules as follows  $E_{T,up}(\sigma_z)$  – as the tangent with any optional stress at the load curve and  $E_{T,down}(\sigma_z, \sigma_{upper})$  – as the tangent with any optional stress at the unloading curve taking into account the stress reversal  $\sigma_{upper}$  from the load to the unloading curve and according to the secant rope elongation modules  $E_S(0, \sigma_{upper})$  – as the secant between the lower stress  $\sigma_{lower} = 0$  of an optional stress level  $\sigma_{upper}$  and  $E_S(\sigma_{lower}, \sigma_{upper})$  – as the secant between two optional stress levels  $\sigma_{lower}$  and  $\sigma_{upper}$  subject to stress reversal at  $\sigma_{upper}$ . An illustration of the different definitions of the rope elongation module can be seen in Fig. 39.

For current ropes the rope stress elongation curves have to be measured and the elongation modules determined separately. These ropes also include 9-strand rope constructions such as the DRAKO 300 T and 300 TX and/or ropes with compacted strands. During these tensile tests, the rope tensile stress is continuously increased up until around 10% of the rope minimum breaking strength. The elongation is measured and recorded. After releasing the tensile stress on the rope to the starting value, 10 cycles are executed with a load of up to 50% of the rope minimum breaking strength, then the stress is released. Subsequently load is applied again to 10% of the rope minimum breaking strength and released with stepped measurements of rope elongations. Fig. 40 illustrates the rope stress elongation curves for a DRAKO 300 T rope when new and after threshold stress application. It is evident that the curves are steeper after loading, i.e. the rope elongation module rises. In addition, the load and unloading curve converge at the starting value, i.e. the remaining initial elongation is no longer increased after a short period with these ropes. Consequently, in conditions typically occurring in elevators for an elevator installation with a vertical rise of  $H = 400$  m, elongation of substantially between 1 and 2 mm results per additional load unit of  $q = 100$  kg. It can also be stated that, given equal loading, 6-stranded ropes have a shorter elongation than 8-stranded – this because of the wider metallic cross-section. Lang lay ropes have larger elongations than regular lay ropes under otherwise equal conditions.

Fig. 39: Rope elongation module as per [36]

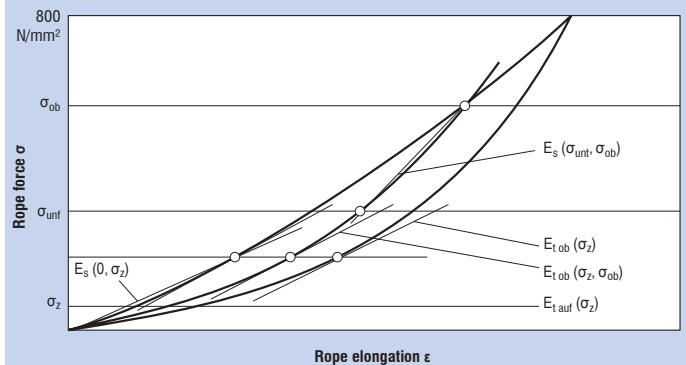
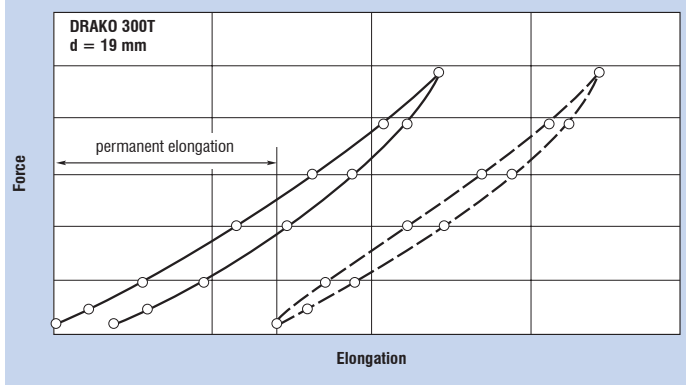

Fig. 40: Rope strength / rope elongation parameters DRAKO 300 T





## FAQs

### Precautionary shortening

#### Shortening ropes and permanent elongation

The horizontal distance between the two measurement curves in Fig. 40 is explained by what is known as “initial rope elongation”, an irreversible process. In an elevator, this elongation is the reason for the necessity to shorten ropes following installation. According to conclusions made as the result to the afore-mentioned method of measurement, the permanent elongation is crucially dependent on the rope design. A class 6x19 + fibre core rope has a slightly lower permanent elongation (0.3%) than a class 8x19 + fibre core rope. In the case of ropes with an independently manufactured steel rope core (IWRC), this value depends on the respective rope structure and generally lies below 0.15%. Double parallel ropes lie at 0.1% or lower.

### Spring deflection of the car under load

#### Spring deflection of the car under load

Spring deflection of the car is the sum total of the elevator components absorbing the load from the spring system – components such as the ropes, springs and dampers within the rope suspension, the frame, floor and ceiling elements and the vibration insulation between frames and car as well as the insulation elements of the elevator machine. Due to the non-linearity of the rope strength / rope elongation parameters, the proportion of cabin cushioning from the rope is dependent on the position of the operating point. In the case of linearity, rope elongation would only be dependent on change in load.

“Direct” connection of the car to the traction sheave using ropes with low elastic elongation is synonymous for many elevator users with a high level of ride comfort.

The transition from an 8x19 + FC construction rope to a rope with a steel wire core reduces elastic rope elongation by around 50% if the other installation parameters are kept constant. This notable difference is the result firstly of the different E modulus, and secondly of the far larger metallic rope cross-section with steel core.

Note:

Should the elongation behaviour of ropes be contrary to experiences gained over the course of operation, a check should be carried out on whether this is due to an installation error – here untwisting of the rope. Rope end terminations which have not been secured against rotation can also be the cause of untwisted ropes. In particular, ropes with steel wire core demonstrated substantially higher elastic elongation when untwisted, as the outer strands are loosened and the load increasingly suspended only on the steel core. Similarly, large variations in rope tension can have a negative impact on cabin cushioning since load is not distributed evenly over all the ropes. Moreover, ropes can age at different speeds and this too can have irreversible effects on elongation behaviour and rope service life.

The practice of “improving” the elongation behaviour of ropes by simply twisting them – even if they are perfectly correctly installed – is highly inadvisable. Although it can actually reduce rope elongation in the first place, this practice can also have the effect of drastically reducing rope life.

### Relubrication

#### Should ropes in the elevator be relubricated?

Elevator ropes are lubricated during manufacture in order to prevent corrosion and abrasion between the wires. However, the quantity of lubricant applied should only be enough to ensure that elevators operate with sufficient traction and without slippage. As lubricants also tend to bind dust and abraded particles, this initial lubrication is hardly ever sufficient to be effective over the entire service life of the rope. It is advisable to occasionally relubricate elevator ropes. As long as wiping a finger over the rope shows a faint smudge, there is no need for lubrication. Make sure that the lubricant used is compatible with the basic lubricant applied at manufacture. If in doubt, consult the original rope manufacturer. Further information about rope lubrication can be found in EN 12385-5.

**Criteria**

**What criteria are applicable to relubrication?**

It is not possible to provide any definitive statement in respect of relubrication intervals, as they depend on:

- the frequency of elevator use,
- the environment (temperature, humidity, incidence of dust),
- the sheave material and sheave wear (hardened traction sheaves require more relubrication, as no graphite is released from the sheave as a result of wear) and
- slip between the rope and sheave.

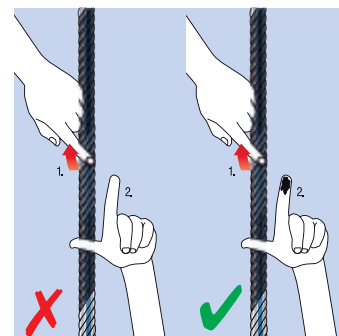

**Methods**

**Which methods for relubrication could be recommended?**

Relubrication using fluid lubricants can be carried out using a can of lubricant and a paintbrush or decorator's roller. Lubricant spray cans should only be used for small rope lengths. In any case, only very minimal quantities should be applied, after which the elevator should execute several complete round trips, paying attention to observe the slip behaviour. Afterwards, further lubricant can be added if necessary.

If you are in any doubt as to whether the rope still has adequate traction after relubrication, carry out a round trip. When car is completely up again, make a joint chalk mark across the rope and sheave, car completely down and then back up again. The offset of the chalk marks gives is the indication of rope slip.

Permanent lubrication devices can cause overlubrication problems when used continuously and in installations where there is little reserve in traction.

**Lubricants**

**What properties should a lubricant have?**

The lubricant should not be too low in viscosity, but have sufficient penetrative capability to get inside of the rope.

The most suitable lubricants appear to be rope lubricants diluted with solvent. When used with caution (good ventilation) and not excessively applied (a solvent which has not quite evaporated compromises traction) this has proved the ideal combination.

In some countries, however, relubrication agents containing solvent are prohibited for occupational safety reasons. Here and in all other cases of doubt, always check back with the original rope manufacturer. Hydraulic oils or worm gear oils are unsuitable.

Lubricants with particle content (such as molybdenum sulphide or Teflon particles) are also unsuitable for traction elevators, as these agents can reduce the friction between rope and groove to an inadmissibly high degree.

Ropes for roped hydraulic elevators, drum-driven elevators and compensating ropes can, if necessary, be more heavily lubricated.

As a result, this type of ropes may be relubricated with suitable grease since here the precise amount of lubricant is not as critical as with traction sheave ropes. Generally speaking, however, the lubricating oils customarily used on traction sheave ropes would also be used in these applications.

**Characteristics**

**What special characteristics should be considered when recommending lubricants for unusual elevator installations?**

**Humidity in the shaft:**

No special precautions, only more frequent checks. If applicable, use galvanized ropes.

**Outdoor elevator installations:**

Apart from installations in extremely dry climates, galvanized elevator ropes can be used. The basic lubrication provided when the ropes are manufactured should not in this case be normal rope lubricant, which can be washed away by water, but a water-resistant medium. Special types of

## FAQs

lubricant exist for this purpose. Relubrication, which is also essential for galvanized ropes, should be performed without fail using lubricants containing solvents. These should be applied during cooler weather (the solvent should not evaporate as quickly) and after extended dry periods.

**Elevator installations operating in high or low-temperature environments:** No special measures are required for temperatures ranging between 0 and 50 °C.

Where temperatures are constantly between 40 and 50 °C, the condition of the lubrication should be checked at more frequent intervals, as the lubricant becomes less viscous and is used up more quickly.

### Dosage

#### How much lubricant is there in the fibre core?

Requests are sometimes heard for the fibre core to be provided during manufacture with a lubricant that will last the lifetime of the rope or possibly several decades. It would be an easy matter for a rope manufacturer to inject a generous helping of grease (for instance 25%) into the fibre core. But far from the desired effect of providing gradually metered lifetime lubrication, the excess grease would seep out within just weeks after fitting the rope. However, the main reason for carefully limiting the grease content of the fibre core becomes evident on studying Fig. 41, which illustrates the cross-section of a new, unloaded 8 x 19 Seale + FC elevator rope. The outer strands are supported on the fibre core; the rope diameter is consequently determined by the volume on the inside of the rope (= fibres + grease). As the life of an elevator rope is closely linked to its effective rope diameter, it is essential for the fibre core to maintain its volume for as long a period as possible. Relubrication should thus be performed from the outside in such a way that lubricant also penetrates the fibre core.

Fig. 41: Support of the outer strands on the fibre core

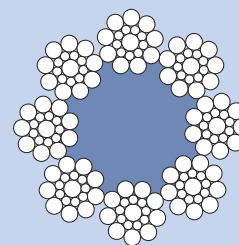

### Degreasing

#### Degreasing over-lubricated elevator ropes

One of the possible causes of excessive slippage of ropes on the sheave can be over-lubrication of the rope.

In no circumstances should an attempt be made to wash down ropes using cleaning agents or solvents. The solvent penetrates the rope and draws an ever greater amount of lubricant towards the outside.

To degrease ropes from the outside, we use a very fine, neutrally reacting powdery quartz flour available on the market as Florideal. For example, this powder can be applied by forming a funnel shape with gloved (!) hands and slowly dusting the ropes with the powder in a downward direction from the traction sheave (machine positioned at the top). The powder absorbs the oil and grease. The dried mass then crumbles away. Finally, brush away what remains of the powder/grease mixture using a wire brush. The sheaves should also be cleaned, possibly using solvent.

### Discarding of wire ropes

#### When must elevator ropes be discarded?

Elevator ropes tend to be discarded due to wire breaks, wear-and-tear or diameter reduction. However, other discarding criteria such as corrosion, coarse damage or excessive elongation can also have an adverse effect.

### Criteria

#### How many wire breaks are admissible?

The number and distribution of externally visible wire breaks are the most important criteria when it comes to detecting when an elevator rope should be discarded. This is quantified by a count of the maximum number of visible wire breaks over a reference length of the rope. According to ISO 4344 [3], the maximum number of wire breaks over one length of lay must be determined separately

- for all outer strands and
- for the two most heavily damaged outer strands

**Wire breaks**

and also evaluated separately. (Fig. 42, Fig. 43) For 6 and 8-strand elevator ropes with fibre core, ISO 4344 [3] provides an indication of the maximum admissible number wire breaks. Taking the number of wire breaks at discard as a reference, it is then possible to determine whether the rope should be discarded immediately, should be more intensively monitored in the future or should continue to be monitored normally (Fig. 44). To avoid strand breaks and the relevant consequential damage, the maximum admissible number of wire breaks must also be examined in accordance with ISO 4344 relative to the crown of a strand.

For all other elevator ropes, reference is made to the specifications of the relevant rope manufacturer. As regards the 9-strand rope, the wire break discard criteria set out in Fig. 45 (over two different reference lengths and, similarly, over a single strand) have stood the test of time. The wire break discard criteria based on DIN 15020 [20] are smaller than those based on ISO 4344 [3] – i. e. they are on the safe side.

In old installations in compliance with TRA 102 [21], elevator ropes are classified, monitored and discarded under the highest drive group of DIN 15020 [20] / ISO 4309 [22].

If the outer wires show heavy signs of abrasion, the wires are likely to break at these points and in relatively quick succession. If wire breaks are evenly distributed as illustrated in Fig. 42, the residual service life can be estimated with relative ease.



Fig. 42: Wear marks and wire breaks

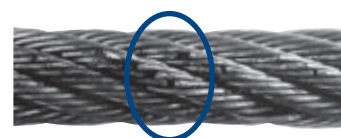

Fig. 43: Wire break nest

Fig. 44: Discard criteria EN 12385-5 and ISO 4344 with discard criteria extended and tightened, also for 9-strand ropes, according to EN 81-20/-50, based on DIN 15020 [20] (For the chart, please Appendix

Rope design	Number of wires in the outer strand	Number of wire breaks on a length of 6 x rope Ø	Number of wire breaks on a length of 30 x rope Ø
DRAKO 6x19S – FC	= 114 wires	6	12
DRAKO 6x19W – FC	= 114 wires	10	19
DRAKO 6x25F – FC			
DRAKO 180B (in 6x25F – FC)			
DRAKO 8x19S – FC	= 152 wires	10	19
DRAKO 250H, 8 mm			
DRAKO 8x19W – FC	= 152 wires	13	26
DRAKO 8x25F – FC			
DRAKO 250T			
DRAKO 250H (except 8 mm)			
DRAKO 200B			
DRAKO 300T, 8 mm	= 171 wires	14	25
DRAKO 300 T (except 8 mm)	> 180 wires	16	32
DRAKO 180B (in 6x36WS – FC)	= 216 wires	18	35

Fig. 45: Discard criteria according to EN 12385-5 and ISO 4344, extended and tightened, based on DIN 15020

Criteria	Discard or examination within the time span prescribed by an expert			immediate discard		
	Rope grade 6 x 19	Rope grade 8 x 19	Rope grade 9 x 19	Rope grade 6 x 19	Rope grade 8 x 19	Rope grade 9 x 19
Average number of wire break among outer strands	More than 12 per length of lay	More than 15 per length of lay	More than 17 per length of lay	More than 24 per length of lay	More than 30 per length of lay	More than 34 per length of lay
Number of wire break predominantly in one or two strands	More than 6 per length of lay	More than 8 per length of lay	More than 9 per length of lay	More than 8 per length of lay	More than 10 per length of lay	More than 11 per length of lay
Number of wire break adjacent to another in one outer strand	4	4	6	More than 4	More than 4	More than 6
Intermediate wire break (Valley breaks)	1 per length of lay	1 per length of lay	1 per length of lay	More than 1 per length of lay	More than 1 per length of lay	More than 1 per length of lay



## FAQs

The European Rope Standard EN 12385-3 [23] refers to ISO 4344 for elevator ropes in this context.

In non-European countries, the relevant national regulations apply to determining when a rope should be discarded.

The number of wire breaks can sometimes fail as a discard criterion under certain circumstances. Wire breaks due to external wear only occur when the sheaves, in particular the traction sheaves, in a rope drive system are made of grey cast iron or steel. If only plastic sheaves are used, the safety directive for elevators "Plastic rope sheaves" must be observed, as here under certain circumstances inner wire breaks can occur rather than outer ones.

### At what level of reduction in wire diameter should ropes be discarded?

#### Reduction in wire diameter

Due to external and internal wire wear, over long service periods a continuous diameter reduction can take place in elevator ropes. In ropes with fibre core, this effect is exacerbated by the drying out and abrasion of the fibre core.

With a diameter reduction of 6% relative to the nominal diameter (a 13 mm rope reduces to a diameter of 12.2 mm), the elevator rope should be discarded immediately, because

- there is a risk of sudden rope breakage, e.g. due to inner wire breaks at the contact points between strands (Fig. 46);
- the traction calculation is based on the fact that the rope fits precisely into the groove. Consequently, the projected traction is no longer provided if the elevator ropes are too thin; and
- traction sheave grooves abraded by ropes which are too thin are therefore too narrow for new ropes, which are then inevitably damaged.

Fig. 46: Strand contact and notching

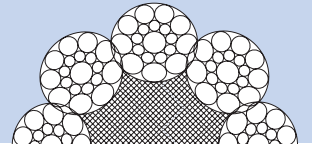

### What should be done in case of rust development in the strand gaps?

#### Corrosion

If there is evidence of abraded red particles exuding from the rope strand gaps, the rope diameter should be checked in the affected rope sections for reduction in diameter. In the case of diameter reductions of less than 4% relative to the nominal diameter, further reduction can be slowed down by relubrication. Suspected causes for the formation of more commonly known in some countries as rouging or red dust are insufficient lubrication, incorrect relubrication and a damp or aggressive shaft atmosphere.

Where a diameter is reduced by more than 6% relative to the nominal diameter, generally speaking a rope change is necessary. In this case, the suspected cause for corrosion formation is excessive friction between the outer strands. Normally, the outer strands rest on the rope core, and friction between the outer strands is minimal. However, if the diameter of the rope core reduces due to rope wear, the outer strands begin to mutually support each other, with the result that greater friction occurs between them. The abraded particles produced by this process are not metallically bright but red-brown in colour (fretting corrosion). This abrasion process is known as "rope bleeding", and the rust powder that evolves is also termed "red dust" or "rouging" [24]. The risk lies in the possible resulting inner wire breaks which only become visible after load relief and extreme bending of the rope (Fig. 47 and 48). The long wire break ends are characteristic of this phenomenon.



Fig. 47: Rope in accordance with Fig. 49 when stretched



Fig. 48: Rope in accordance with Fig. 49 when bent

**Traction sheaves**

**Groove shapes**

**Wear**

## Traction sheaves

### What types of different groove shape are there?

A distinction is drawn between shaped grooves (V-grooves, U-grooves with undercut) and round grooves. The groove shape exerts not only a significant effect on the traction but also on the rope service life. Generally speaking, the more comfortably the rope is bedded, the longer rope service life will be and the lower the traction.

The grooves can become worn with operation, and must be subjected to a special inspection when changing ropes. New ropes, perhaps those at the upper end of the diameter tolerance, will respond to worn and excessively small grooves with a shortened service life.

Another damaging influence on rope service life is a groove worn to an uneven depth, in particular in drive systems with double wrap. The ropes run at different speeds and a different height in such grooves (not equal with each other). Because of the difference in height between the grooves, a slack condition occurs in some of the ropes which, as a result, causes excessive slip and this is indicated in some cases by an audible creaking noise. That being so, the rope sections between the traction sheave and secondary sheave of the double wrap can be exposed to extremely high "strain tension".

When changing the rope, the groove profiles of unhardened traction sheaves should always be remeasured. The measurement gauges for the grooves should always be graduated in 1/10 mm steps. Fig. 49 shows examples of gauges produced internally by PFEIFER DRAKO. At which difference in diameter between new and worn groove, one should consider replacing the traction sheave depends on whether

- there is too much traction being created by this pairing, and the car is drawn towards the shaft ceiling during CWT on buffer tests;
- unavoidable service life reduction due to increased contact pressure is acceptable; and
- the ropes in question have a fibre or steel core.



Fig. 49: Example of radius gauges (own production)

**Remachining**

### Remachining of traction sheaves

During elevator maintenance, the discovery is frequently made that whilst a sheave may have worked without problems for between 10 and 15 years with its original rope set, after remachining the sheave when carrying out a rope change, abrasion or rope impressions occur at a far faster rate. In an analysis of the serviceability of this type of remachined sheave carried out 25 years ago by one of the automotive manufacturer of around 700 elevator installations, this type of behaviour was actually statistically proven to be typical of remachined sheaves. It was proven that 60% of such sheaves had to be exchanged again after only one year in operation. This contradicts what would appear to be the obvious conclusion – that the new ropes are at fault. In fact they are not. Not all new ropes can have resulted in the recorded cases of groove damage. It is conceivable that the cast iron in the groove area can have gradually become crumbly though decades of exposure to swelling pressure and that the top layer of the groove profile which has been smoothed over time now begins to react sensitively.

### What is an unhardened traction sheave?

The material used to make traction sheaves cannot be easily determined without detailed metallographic examination. However, the hardness of the traction sheave can be measured. Long-term studies have shown that at a sheave with a hardness of up to 180 HB (Brinell hardness) signs of rope impressions or higher levels of groove wear have occurred. At a groove hardness of between 180 and 195 HB the probability of this kind of damage occurring is reduced. With increasing groove hardness to above 200 HB, or better still over 210 HB, this type of damage pattern becomes highly unlikely.

For GG 25 grey cast iron, the hardness limit achievable using modern foundry methods is around 230 HB. The hardness test should only be

**Unhardened traction sheave**

## FAQs

executed on the machined surfaces of the casting and by preparing the top layer of the machined surface otherwise the measured results will be incorrect. Pressure produced by the test process must be sufficient to ensure that this prepared surface is penetrated.

Spherical graphite cast iron GGG 60 demonstrates better material characteristics than GG 25, but is also more costly. Experience and analyses gained from expert consultation demonstrate that it is not only the hardness of the groove which determines resistance to wear, but also the alloy component such as the copper (CU), which substantially increases wear resistance. Wear characteristics are also influenced by the formation and distribution of the graphite particles in the cast iron. The fact that the sheaves are no longer stored prior to utilization but machined and mounted immediately after casting can also have a detrimental effect on the material properties.

### Hardened traction sheave

#### What is a hardened sheave?

The practice of hardening V-grooves has been customary since around 1967. Hardened, undercut U-grooves have been a familiar feature since around 1978. When using hardened rope grooves, it should be noted that:

- the profile of the different grooves and groove depth must be correctly matched (“If the groove is hardened, the rope is no longer able to help correct the groove”);
- the edges of the undercut must be well-rounded as otherwise two deep wear lines will appear in the ropes;
- the ropes must be relubricated regularly at all costs;
- ropes which become too thin – more so than is the case with the unhardened traction grooves which share in the wearing process – run onto the edges of the undercut, resulting in insufficient traction and
- U-grooves with a 105° undercut should be avoided where possible, as once the necessary rounding of the undercut edges has been carried out, no appreciable rope seat is left, and the rope becomes deformed – especially when using a 8 x 19 + fibre core rope construction. In the worst case scenario, the rope will run on to the edges of the undercut and react by premature failure.

#### Traction sheave with plastic inlays or made of plastic

A plastic or plastic inlay traction sheave in which traction can be radically increased by the use of plastic is a practically unknown phenomenon in Europe. When pairing, it is important to bear in mind that this can impede detection of the discard age by externally visible wire breaks. However, it is also true to say that these sheave materials are used successfully in other countries.

While TRA 003 and EN 81/1986 still stipulate a binding requirement for grey cast iron or steel traction sheaves, specifying a coefficient friction of  $\mu = 0.09$ , in EN 81-1/1998 and EN 81-50/2014 the required coefficient of friction is specified relative to the nominal speed of the elevator installation. As a standard is recommendatory in character, evidence of equality in terms of safety leaves the door open for the use of alternative traction sheave materials.

#### What is contact pressure?

Elevator manufacturers should still pay attention to the contact pressure occurring between rope and groove. By adjusting contact pressure, for example to the frequency of use, it is possible to exert an instrumental influence on load and consequently on the service life of the rope. However, in EN 81-1/1998 there is no mention of the contact pressure calculation which was featured in the previous version of the standard. Contact pressure is “indirectly” included in the calculation of the safety factor in accordance with Annex N of EN 81-1. Although focus has correctly been placed on a minimum rope service life, the standard neglects to include an explicit verification of contact pressure. It can be said that a configuration

### Contact pressure

in compliance since EN 81-1/1998 permits significantly higher contact pressure than was admissible according to EN 81-1/1986. The fundamental correlation between contact pressure and serviceability was established as far back as the standard reference work on traction [25] published back in 1927 (Fig. 50).

### Regulations

Rope manufacturers usually only ever get the opportunity to see machine rooms if rope service life is shorter than the operator anticipated. In many cases, it becomes evident that although the design has been performing in accordance with EN 81-50, where a safe minimum service life is in the background of the calculation, this should not be confused with an elevator which is balanced to achieve maximum economic efficiency. It frequently occurs that the parameters which determine the service life of a rope are stretched to their limits, which in return brings about a corresponding reduction of service life. To increase user satisfaction, there should be better communication between partners at the pre-planning stage of the design to determine the expectations placed on service life. This should increase awareness of the fact that a long service life is associated with costs.

When it comes to that decision-making process, certificate concerning the examination of conformity CA067 [26] offers assistance in calculating the expected number of trips for the practically freely selectable safety factors  $S_r \geq 12$  to  $D/d = 18.5$  ( $d = 6.5$  mm DRAKO 250 T). Proof of traction must be provided. In future, this will also be possible for elevators requiring longer service lives. But that will assume close contact between elevator producer, operator and rope manufacturer.

### Deflection and diversion sheaves

Deflection and diversion sheaves should be made of the same high-grade cast iron as traction sheaves. The grooves of deflection and diversion sheaves rarely wear to such a degree that new ropes could be damaged as a result. Despite this, when the ropes are changed, the grooves of the deflection and diversion sheaves be inspected for worn grooves. This inspection should extend to include a check on the bearings and on the alignment. The frequently voiced opinion that a sheave which has a minimal wrap angle is consequently exposed to minimal stress is a misconception. Contact pressure, in other words the force per millimetre of wrap length, is just as great as if the sheave had a wrap angle of, for instance,  $180^\circ$ . Here too, the degree of contact pressure determines the extent of sheave and rope wear. According to elevator manufacturers, the use of universal sheaves for a range of rope diameters has not proven successful. Deflection sheaves can be made of plastic, for example polyamide. Their use is regulated in Germany by the Safety Guidelines for Lifts SR Plastic Sheaves [27]. There is no concern regarding the use of plastic sheaves in conjunction with a steel or grey cast iron traction sheave. The discard age of the ropes can be determined by symptoms such as externally visible wire breaks, which occur as a result of running over the cast iron traction sheave.

Fig. 50: Historical upper limits of contact pressure in elevator traction grooves

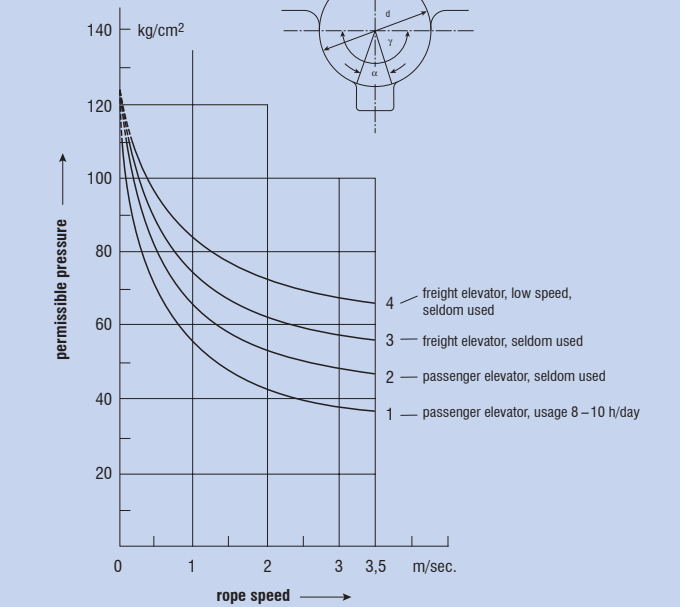

### Regulations

### Certificate concerning the examination of conformity

### Rope sheaves



#### Groove wear in the form of rope impressions (braid formation)

If braid formation (Fig. 51) occurs as a form of groove wear evenly in all grooves and is highly pronounced, then in all probability the sheaves used have an insufficient hardness level.

However, if the sheave hardness is proven to be correct, then there are several other factors which can lead to the occurrence of rope impressions in grooves. These include:

- uneven rope tension levels,
- dry ropes (lack of relubrication)
- rope twist during operation and
- grooves which are excessively worn, e. g. following a rope change without change of a worn traction sheave

In each instance, the quality of the cast iron is instrumental. It is highly likely that a correlation exists between the form of groove wear and rope elasticity. Dips of this type in the groove must have been filed out by a twisting movement of the rope as it runs over the sheave. Experience has shown that 8-strand ropes with a fibre core made of polypropylene are found to be mounted in a disproportionately high number of cases when rope imprints have been discovered in grooves. Conversely, ropes with steel wire core, i. e. ropes with a substantially reduced longitudinal elasticity, are only very seldom found to be responsible for the occurrence of rope impressions in grooves, provided the sheave has sufficient hardness. Experience also indicates that where traction sheaves of inferior cast iron quality and hardness are used, it is possible to avoid excessive groove wear by selecting a “non-hard” rope. In this type of rope, the outer wires of the outer strands consist of wires of a relatively low wire tensile strength of between around 1180 and 1370 N/mm<sup>2</sup>.



Fig. 51: Rope impressions in the grooves of a traction sheave

## Bibliography

- [1] DIN EN ISO 16120, Non-alloy steel rods for drawing
- [2] EN 12385 – Part 5 (2003), Steel wire ropes – Safety Part 5: Stranded ropes for lifts
- [3] ISO 4344 (published 2004), Steel wire ropes for lifts – Minimum requirements
- [4] DIN ISO 18265 Metallische Werkstoffe – Umwertung von Härtewerten [Metallic material – Conversion of hardness], Nov. 2003 earlier  
DIN 50150, Conversion table for Vickers hardness, Brinell hardness, Rockwell hardness and tensile strength, December 1976, Beuth Verlag GmbH, Berlin
- [5] TRA 003, Technical rules for elevators – calculation of traction sheaves, September 1981, Verein der Technischen Überwachungsvereine e.V., Essen
- [6] DIN EN 81, Safety rules for the construction and installation of lifts – Particular applications for passenger and goods passenger lifts Part 1: Electric lifts, October 1986
- [7] EN 81-1/1998, Safety rules for the construction and installation of lifts – Part 1: Electric lifts  
EN 81-20/2014, Safety rules for the construction and installation of lifts – Lifts for the transport of persons and goods – Part 20: Passenger and goods passenger lifts  
EN 81-50/2014, Safety rules for the construction and installation of lifts – Examinations and tests – Part 50: Design rules, calculations, examinations and tests of lift components
- [8] ASME A 17.1 Safety Code for Elevators and Escalators. The American Society of Mechanical Engineers, New York
- [9] EN 13411 – Part 4 (2002), Terminations for steel wire ropes. Safety. Part 4: Metal and resin sockets
- [10] EN 13411 – Part 3 (2003), Terminations for steel wire ropes. Safety – Part 3: Ferrules and ferrule-securing
- [11] EN 13411 – Part 1 (2002), Terminations for steel wire ropes. Safety – Part 1: Thimbles for steel wire rope slings
- [12] EN 13411 – Part 7 (2004), Terminations for steel wire ropes. Safety – Part 7: Symmetric wedge socket
- [13] EN 13411 – Part 5 (2003), Terminations for steel wire ropes. Safety – Part 5: U-bolt wire rope grips
- [14] EN 13411 – Part 6 (2003), Terminations for steel wire ropes. Safety – Part 6: Asymmetric wedge socket
- [15] Czitary, E., Seilschwebbahnen [Cable pulleys], Springer Verlag, Vienna, 1951  
Wyss, Th., Stahldrahtseile der Transport- und Förderanlagen [Steel wire ropes in transport and conveyor systems] Schweizer Druck- und Verlagshaus AG, Zurich 1956
- [16] Feyrer, K.: Drahtseile. Bemessung, Betrieb, Sicherheit [Wire ropes. Dimensioning, Operation, Safety], Springer-Verlag 2000
- [17] Feyrer, K.; Jahne, K.: Seilelastizitätsmodul von Rundlitzenseilen [Rope elastic modulus of round strand ropes], DRAHT 41 (1990) p. 498–504
- [18] DIN EN 1993 Bemessung und Konstruktion von Stahlbauten/Teil 1-1: Allg. Bemessungsregeln und Regeln für den Hochbau [DIN EN 1993 Dimensioning and design of steel constructions / Part 1-1: General dimensioning rules and rules for super-structure]
- [19] VDI 2358 Drahtseile für Fördermittel [Wire ropes for conveyor], 10.1984
- [20] DIN 15020, Principles Relating to Rope Drives sheet 2, monitoring of rope installations, April 1974, Beuth Verlag GmbH, Berlin
- [21] TRA 102, Technische Regeln für Aufzüge – Prüfung von Aufzugsanlagen, [Technical rules governing lifts – inspection of lift systems] April 1981, Verein der Technischen Überwachungsvereine e.V., Essen
- [22] ISO 4309, Wire ropes for lifting appliances – Code of practice for examination and discard, 1990
- [23] EN 12385 – 3 (2003), Steel wire ropes – Safety – Part 3: Information for use and maintenance
- [24] Wire Rope Users Manual, American Iron and Steel Institute, Washington
- [25] Hymans, F./Hellbronn, A.V., Der neuzeitliche Aufzug mit Treibscheibenantrieb [The modern lift with traction drive], Springer Verlag
- [26] CA067 Bescheinigung über eine Konformitätsprüfung – Seiltrieb zur Verwendung als Teil des Triebwerks für Treibscheibenantriebe bzw. indirekt hydraulisch betriebene Aufzugsanlagen, mit und ohne Fahrtenreduzierung, Juni 2016 von TÜV Süd für PFEIFER DRAKO [CA067 Certificate concerning the examination of conformity – Rope drive for use as part of the machine for traction drive lifts resp. indirect acting hydraulic lifts with and without reduced number of travels, Juni 2016 by TÜV Süd for PFEIFER DRAKO]
- [27] SR Kunststoffrollen, Sicherheitstechnische Richtlinien für Aufzüge – Seilrollen aus Kunststoff [SR plastic sheaves, safety guidelines for lifts – plastic sheaves], December 1984, Carl Heymanns Verlag KG, Cologne, Berlin

# Guidance for the selection of ropes

## Which rope for which elevator installation?

This recommendation is based on empirical values and is intended as an aid to selection of the most suitable rope configuration.

Check Charts 1 to 4 according to your type of application. You will find the "correct" rope construction in Table 5.

Please pay also special attention to our customized solutions as e.g. in small diameter ropes and low D/d ratios. Type examination certificates or recently certificates concerning the examination of conformity for simplified approval of your installation are available at DRAKO.

**Table 1** Traction elevators

Rope length	Rope configuration					
	Frequency of use			high comfort expectation	high quiet running	Complex rope guidance
	low	medium	high			
≤ 40 m	C	C	C	D	D	E
≤ 100 m	C	D	E	E	E	E
≤ 150 m	D	E	E	E	E/F	E
≤ 200 m	E	E/F	E/F	E/F	E/F/H	E
> 200 m	E	E/H	E/H	E/H	E/H	E

General requirements:

- Precisely metered lubrication due to traction drive
- Narrow rope diameter tolerance
- Strength of outer wires in lower range of tolerance field

**Table 2** Roped hydraulic elevators

For service life and maintenance	Rope configuration		
	low	medium	high
Good solution	G	G	G
Better solution	–	G	G

General requirements:

- Well but not excessively lubricated
- Higher nominal wire strengths possible, as high breaking force is particularly desirable in this case
- Rope diameter tolerance as for non-elevator ropes: –0 +5 %

**Table 3** Tensioned balance ropes

Rope diameter $\varnothing$	Rope construction
Up to 24 mm	K
Greater than 24 mm	L

General requirements:

- Well but not excessively lubricated
- No high breaking force required (Total breaking force of balance ropes smaller than total breaking force of suspension ropes)
- Rope diameter tolerance as for non-elevator ropes
- Fibre core, due to rotation tendency of balance ropes
- Fibre core made of synthetic material (ropes with fibre core made of natural fibre react to high levels of humidity with a change of length)
- Not Longs lay ropes

**Table 4** Ropes for overspeed controllers (governor ropes)

Required rope grade	Rope construction
normal	M
high	N
very high	P

Requirements:

- Precisely metered minimal lubrication
- For humid climatic conditions: galvanized and with synthetic fibre core

**Table 5** Suitability of rope constructions for individual rope configurations as per tables 1 to 4

Rope construction	Corresponding special DRAKO elevator rope	Benefits	Drawbacks	Recom. rope configuration				
				Rope grade				
				1370 or 1370/ 1570	1370/ 1770	1570 or 1570/ 1770	1770	1960
6-strand with fibre core	6 x 19 Seale + FC	Insensitive to mounting, price, otherwise in our opinion no benefits	With increasing diameter rigid to very rigid, see also 6 x 19 Warrington	-	-	M	N	-
	6 x 19 Warrington + FC	Compared to 8-strand ropes, greater breaking forces,	When used with V-grooves and undercut grooves, in some cases vibrations and heavy groove wear	-	-	M	N	P
	6 x 25 Filler + FC 180 B*) 6 x 36 Warrington-Seale + FC 180 B*)	The fibre core makes the balance rope less susceptible to the frequent occurrence of rope rotation due to the relatively weak rope tension.	With full steel upper ropes, more or hicker balance ropes are required or weight compensation	K L	-	K L	-	-
8-strand with fibre core	8 x 19 Seale + FC or 8 x 19 Warrington + FC or 8 x 21 Filler + FC	Universal rope for normal elevators, insensitive to mounting, adjusts to slightly worn grooves, medium price range.	Lowest breaking force in all ropes listed here, higher rope elongation due to larger fibre core, consequently faster rope diameter reduction than is the case with 6 x 19 and full steel ropes.	-	C	C	-	-
	8 x 25 Filler + FC 200 B*)	See 180 B	Lower weight per metre than 180 B	K	-	-	-	-
6-strand with steel core	6 x 19 Seale or 6 x 19 Warrington + IWRC	Only for governor ropes with higher breaking force requirement	Price higher than 6 x 19 + FC	-	-	P	-	P
Full steel rope 8-strand with steel wire core	DRAKO 250 T	High breaking force, more liberal greasing, lower elongation, fewer rope shortening processes	Price higher than 8 x 19 + FC	-	-	D P	-	-
	DRAKO 210 TF/TFS	High breaking force, easily increased transversal elasticity	Price higher than 8 x 19 + FC	-	-	D	-	-
	DRAKO 250 H	Increased breaking force, low rope elongation, fewer rope shortening processes, less frequent relubrication	Price higher than 6 x 19 + FC	-	-	-	G	-
Full steel rope 9-strand with steel wire core	DRAKO 300 T DRAKO 375 T	High breaking force, low rope elongation, very good service life	Price higher than DRAKO 250 T	-	-	E P	-	E P
Full steel rope 9-strand with double-parallel steel wire core	DRAKO 300 TP	very low elastic elongation, otherwise see DRAKO 300 T	Price higher than DRAKO 300 T demanding installation	-	-	F	-	-

\* Special weight compensating ropes for elevators, for exclusive use as tensioned balance ropes



**Comment:**

If, in the past, you have used rope constructions other than those recommended by DRAKO, this should not be a matter of great concern. You will have used a rope that was suitable but (from DRAKO's point of view) not one of optimal design.

To keep things simpler in the above tables, we did not cover all the theoretically possible applications. Please contact DRAKO if you have different elevator designs.

If your traction sheave has caused trouble by way of insufficient hardness, this may be determining your rope selection. In that case, ropes with dual tensile design (1370/1770 N/mm<sup>2</sup>) or even with a steel core instead of a fibre core should be used.

## Delivery Programme

### Elevator Industry

- special ropes of 6-strand and 8-strand construction
- special ropes with 9 outer strands for high rise/high speed installations
- special compensating ropes
- compensating chains and their suspension means
- ropes for small goods elevators, overspeed controllers and door mechanisms
- ropes for gondola systems with inner electric conductors

### Mechanical and Construction Industry

- special crane and excavator ropes with 8 and 9 outer strands
- rotation-resistant and non-rotating ropes for electric hoists
- non-rotating ropes for tower cranes and mobile cranes
- winch ropes, clamshell ropes and pendant ropes
- slings according to DIN EN 13414-2/-3 and other slinging accessories

### Mining

- Koepe hoist ropes
- drum hoist ropes
- flat hoist ropes
- flat balance ropes
- round balance ropes (multi-layer flat strand ropes)
- haulage ropes for monorail conveyors
- signal ropes

### Shaft Sinking

- rotation resistant and non-rotating stage ropes
- flat hoist ropes
- clamshell ropes
- guide ropes
- direction survey ropes

### Oilfield Industry

- rotary drilling lines according to API Spec. 9A and DIN 5881
- swab and bailing lines
- winch lines
- percussion drilling lines
- air winch lines
- logging lines and wires

### Additional

- rope terminations
- wire rope socks for cables and ropes
- wire rope with polymer cover
- spiral ropes and strands (automotive industry)
- deep sea research ropes.

### Approvals and certifications:

- TÜV Süd
- Approved by Germ. Lloyd, Lloyd's Register of Shipping
- Quality Management-Systems acc. DIN EN ISO 9001
- Environmental-Management-Systems acc. DIN EN ISO 14001
- Energy-Management-Systems acc. DIN EN ISO 50001
- LOM (Spain)
- GOST (Russia)





## General Service

### ■ Technical support

Using the large number of technical configurations available to us, we are pleased to assist you in finding the right solution and combination for your ropes and rope accessories.

As early as the planning and design phases, we will support and advise you as extensively as possible. In addition to years of experience, we have all kinds of calculation aids for elevator rope requirements. We can help you select the best rope for your purposes, understand the rope drive & elevator system and advise you accordingly.

These are the services we offer:

### ■ Rope life cycle / elongation calculation and rope selection (DRAKO Rope Calculator)

A rope calculation is a complex process, with many factors to consider. Our Technical Competence Center (TCC) has gathered far-reaching experience in the field of rope service life assessment and this has led to the creation of professional software. An end-user version of this sophisticated program is available which will help you greatly when it comes to the design of your system.

Further the proven DRAKO Rope Selector has been implemented into the DRAKO Rope Calculator. It helps to calculate the rope drive of your traction sheave elevator as per EN81-1 and, additionally, many any significant values based on standards in place. In this way, we can assess and/or modify the actual choice of rope as well as the effect of the influential components. The result: we can recommend you the best-possible coordinated rope drive system.

Get your account free of charge at [www.drako.de/en](http://www.drako.de/en)

### ■ Rope and system diagnosis

Unexpected damage to rope can never be ruled out in elevator systems, and sometimes the cause cannot be established – at least at first. Our highly experienced experts will help you pinpoint the cause of damage and ensure that the same malfunction does not re-occur after the rope has been changed.

We are happy to advise you free of charge! In the case of more extensive calculations and services having to be provided, we would be pleased to make you an offer.

### ■ Simplified order form

We aim to make the selecting and ordering procedures as easy as possible. To do so, please use our special fax order form which you can copy at will. Alternatively, feel free to order or to place a query at: [info@drako.de](mailto:info@drako.de)

### ■ Stock keeping

For your convenience, we permanently keep in stock all sizes of weight compensating chains and over 80 different rope types and diameters for elevator operations. In fact, there are approx. 1,600 kilometres of rope in our warehouse at any one time, meaning that (subject to prior sale) we can respond swiftly to your delivery requirements.

### ■ Systemized deliveries / ropes and accessories from a single source

Do you need our ropes and/or compensating chains complete with accessories at the building site?

→ We offer tailor-made solutions for ready-packed systemized deliveries.

### ■ Response within 24 hours

If it is foreseeable that we cannot reply to your query in the desired time, we will get back to you within one workday after receipt of your message and let you know:

- who your contact person is, and,
- by when exactly you can expect the reply you need.

### ■ In-house test laboratory

We carry out visual inspection (wire breaks, corrosion, deformation, wear), single-wire testing, total disruption, breaking load determination, grease content determination, elongation measurement and fatigue bending test. If required, we will gladly make you an appropriate offer.

### ■ Homepage

You can find all the technical data on our website at [www.drako.de/en](http://www.drako.de/en)

*"Our goal is your satisfaction. Not just via our products but also via our service"*



# PFEIFER DRAKO

## PFEIFER DRAKO DRAHTSEILWERK GMBH

Rheinstraße 19-23  
D-45478 MÜLHEIM AN DER RUHR  
Tel. +49-208-42901-0  
Fax +49-208-42901-43  
E-Mail [info@drako.de](mailto:info@drako.de)  
Internet [www.drako.de](http://www.drako.de)

## Distributors in Europe

### ■ in Belgium/Netherlands

Handels- en Ingenieursbureau  
Bakker & Co. B.V.  
Postbus 1235  
NL-3330 CE ZWIJNDRECHT  
Tel. +31-78-6101666  
Fax +31-78-6100462  
E-Mail [sales@bakker-co.com](mailto:sales@bakker-co.com)

### ■ in Austria

PFEIFER SEIL- UND  
HEBETECHNIK GMBH  
Harterfeldweg 2  
A-4481 ASTEN  
Tel. +43-7224-66224-0  
Fax +43-7224-66224-13  
E-Mail [office@pfeifer-austria.at](mailto:office@pfeifer-austria.at)

### ■ in Hungary

Liftimpex Kft.  
Liget u. 1  
HN-5000 SZOLNOK  
Tel. +36-56-372524  
Fax +36-56-410586  
E-Mail [liftimpex@externet.hu](mailto:liftimpex@externet.hu)

### ■ in the United Kingdom/Ireland

PFEIFER DRAKO LTD.  
Marshfield Bank, Wollstanwood  
GB-CREWE CW2 8UY  
Tel. +44-1270-587728  
Fax +44-1270-587913  
E-Mail [sales@pfeiferdrako.co.uk](mailto:sales@pfeiferdrako.co.uk)

### ■ in Luxembourg

PFEIFER SOGEQUIP S.À.R.L.  
Zone Industrielle Schifflange-Foetz  
L-3844 SCHIFFLANGE  
Tel. +352-574242  
Fax +352-574262  
E-Mail [sogequip@pt.lu](mailto:sogequip@pt.lu)

### ■ in Russia

000 PFEIFER  
KANATI & PODJÖMNIJE TEHNOLOGII  
Pyzhevskiy pereulok,  
h.5, bld.1, office 108  
RU-119017 MOSKAU  
Tel. +7-495-363-01-27  
Fax +7-495-363-01-28  
E-Mail [kanaty@pfeifer-rossia.ru](mailto:kanaty@pfeifer-rossia.ru)

### ■ in Spain

PFEIFER CABLES Y EQUIPOS  
DE ELEVACION, S.L.  
Avda. de los Pirineros, 25 - Nave 20  
San Sebastian de los Reyes  
ES-28703 MADRID  
Tel. +34-91-659-3185  
Fax +34-91-659-3139  
E-Mail [p-es@pfeifer.de](mailto:p-es@pfeifer.de)

### ■ in Italy

Spanset Italia SRL  
Via Nenni 13/A  
IT-10036-SETTIMO TORINESE (TO)  
Tel. +39-0118-169744  
Fax +39-0118-169791  
E-Mail [info@spanset.it](mailto:info@spanset.it)

### ■ in Greece

Helcoma  
Th. Rotas & Co O.E.  
65 Davaki str,  
GR-17672 KALLITHEA, ATHENS  
Tel. +30-210-951 37 05  
Fax +30-210-951 34 90  
E-Mail [contact@helcoma.gr](mailto:contact@helcoma.gr)

### ■ in Poland

PFEIFER TECHNIKA LINOWA  
I DZWIGOWA SP. Z O.O.  
ul. Wrocławska 68  
PL-55330 KREPICE k/Wrocławia  
Tel. +48-71-3980760  
Fax +48-71-3980769  
E-Mail [info@pfeifer.pl](mailto:info@pfeifer.pl)

## PFEIFER Headquarters

### PFEIFER SEIL- UND HEBETECHNIK GMBH

Dr.-Karl-Lenz-Str. 66  
D-87700 MEMMINGEN  
Tel. +49-8331-937-0  
Fax +49-8331-937-294  
E-Mail [info@pfeifer.de](mailto:info@pfeifer.de)  
Internet [www.pfeifer.info](http://www.pfeifer.info)

## Distributors worldwide

### ■ in USA/Canada

AFD Industries, Inc.  
555 Market Avenue North  
CANTON, OH 44702  
Tel. +1-330-4523300  
Fax +1-330-4522331  
E-Mail [info@afdindustries.com](mailto:info@afdindustries.com)

### ■ in UAE/Dubai

PFEIFER MIDDLE EAST WIRE ROPE  
& LIFTING TECHNOLOGY FZE  
Jebel Ali Free Zone 1, RA08UA07,  
PO Box 263081, DUBAI, UAE  
Tel. +971-4-883-8445  
Fax +971-4-883-8446

### ■ in Australia

Bullivants Lifting & Safety  
Specialists  
1 Bellevue Cct, Greystanes NSW 2145  
Locked Bag 9, Wetherill Park NSW 2164  
Tel. +61-2-86337296  
Fax +61-2-96253400  
E-Mail [sales@bullivants.com](mailto:sales@bullivants.com)

### ■ in Korea

Fine Incorporation  
Room 2511, Masters Tower B/D,  
#553, Dowha-Dong, Mapo-Ku,  
SEOUL 121-815  
Tel. +82 2 704 2794  
Fax +82 2 704 2795  
E-Mail [finc2794@unitel.co.kr](mailto:finc2794@unitel.co.kr)

### ■ in Hongkong/China

Cobelco Industrial Supplies Ltd.  
Room 01, 26/F, Tung Wai Commercial  
Building  
109-111 Gloucester Road,  
WAN CHAI, HONG KONG  
Tel. +852-2889-0080  
Fax +852-2889-7077  
E-Mail [sales@cobelco.com.hk](mailto:sales@cobelco.com.hk)

### ■ in China

PFEIFER STEEL WIRE ROPE  
(SHANGHAI) CO., LTD.  
Building 1, No.366, Chen Xiang Road  
Nanxiang Town, Jiading District,  
Shanghai, China  
CN-SHANGHAI 201802  
Tel. +86-21-56778006  
Fax +86-21-56779229  
E-Mail [info@pfeifer.com.cn](mailto:info@pfeifer.com.cn)

Further information:  
[www.drako.de/en](http://www.drako.de/en)

